

History of Type
Professor Eckler

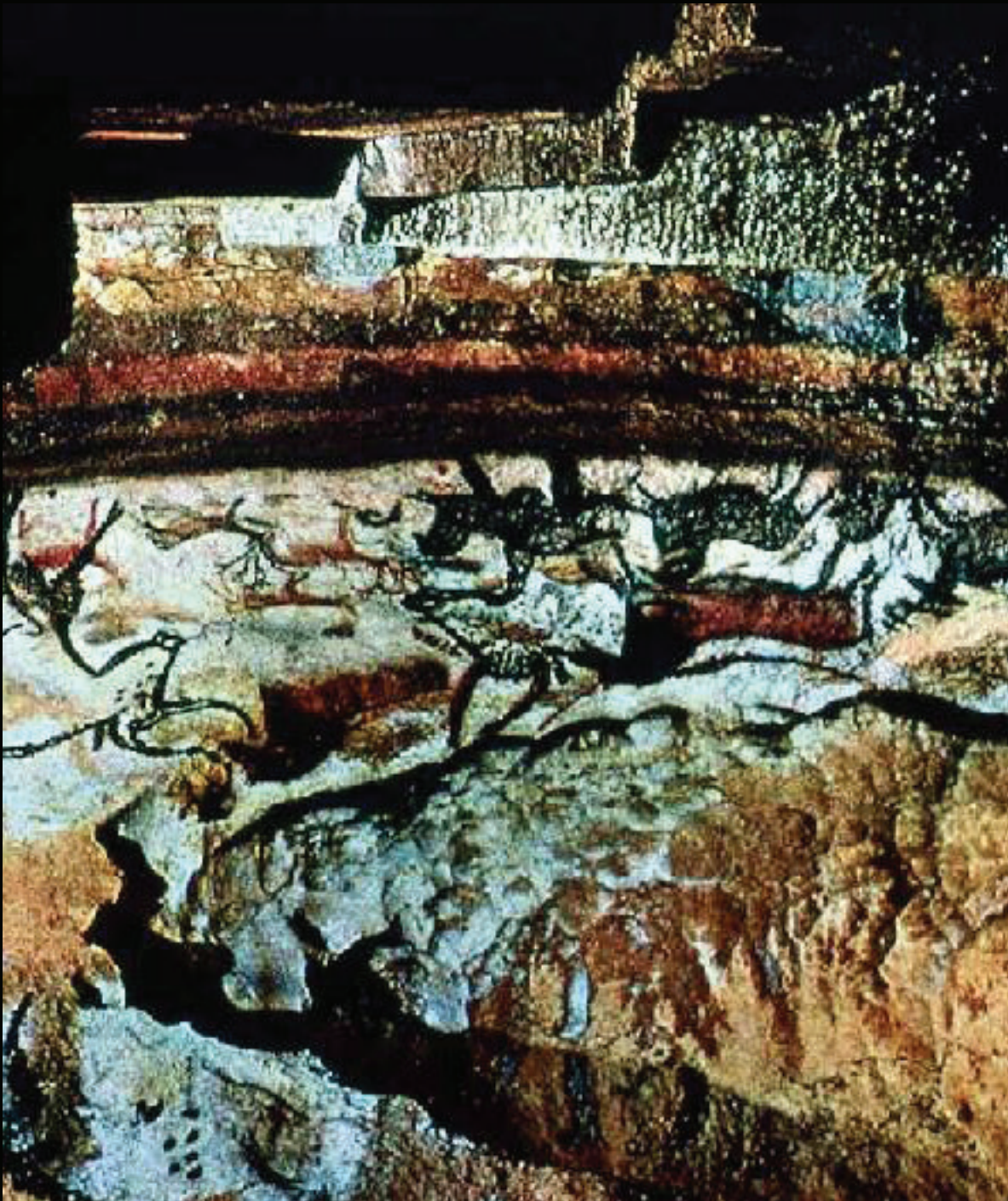

Cave painting from Lascaux, c. 15,000-10,000 B.C. Random placement and shifting scale signify prehistoric people's lack of structure and sequence in recording their experiences.



Early Sumerian pictographic tablet, c. 3100 B.C. This archaic pictographic script contained the seeds for the development of writing. Information is structured into grid zones by horizontal and vertical division.

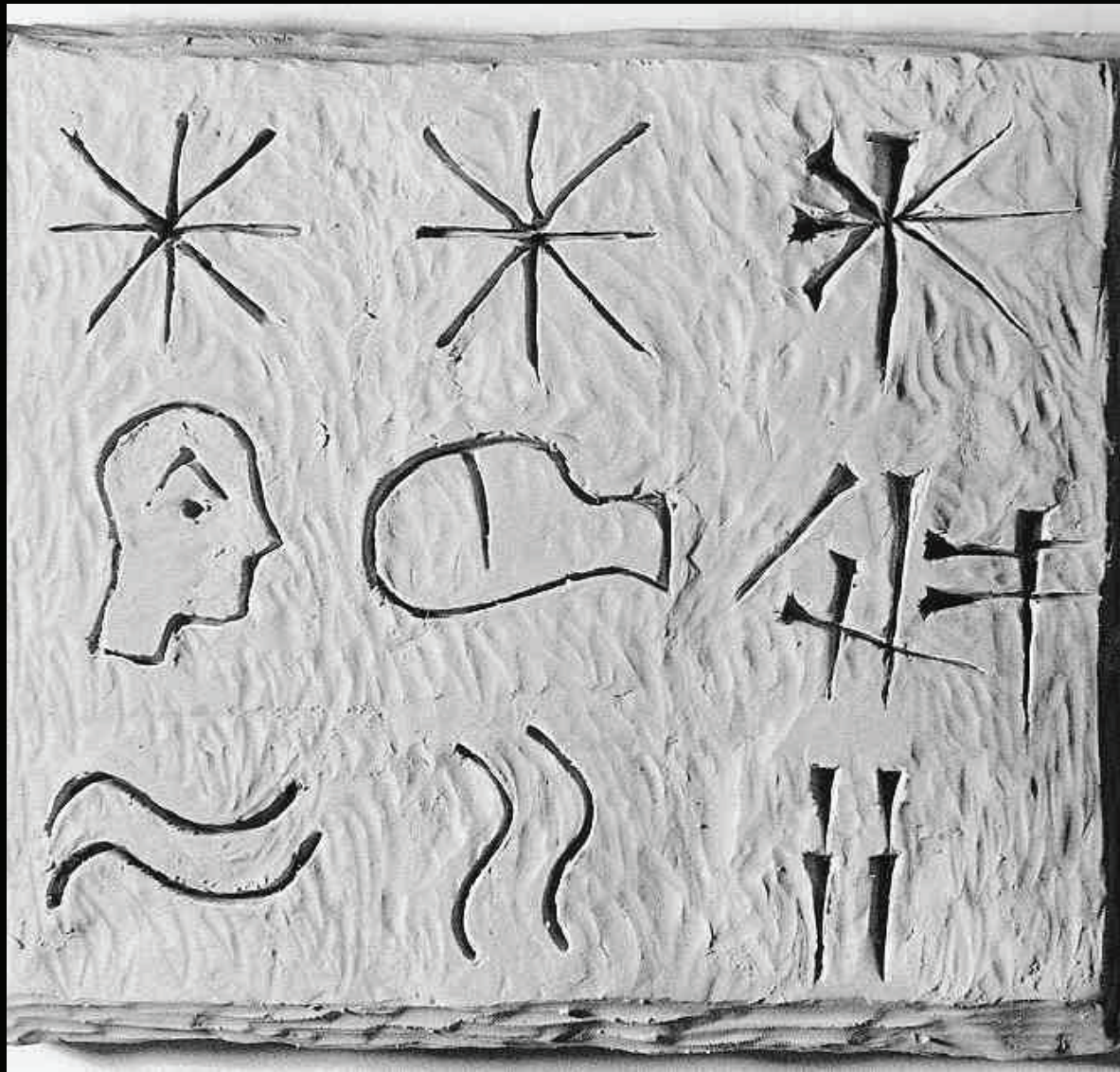

This clay tablet demonstrates how the Sumerian symbols for “star,” “head,” and “water” evolved from early pictographs. The latter were turned on their side by 2800 B.C. and evolved into the early cuneiform writing by 2500 B.C.



Cuneiform writing in which a triangular-tipped stylus is pushed into the clay instead of being dragged through it.



The Blau Monument, early Sumerian. Etched writing and carved relief figures are combined on this early shale artifact.



Stele bearing the Code of Hammurabi, which was initially written between 1792 and 1750 B.C.

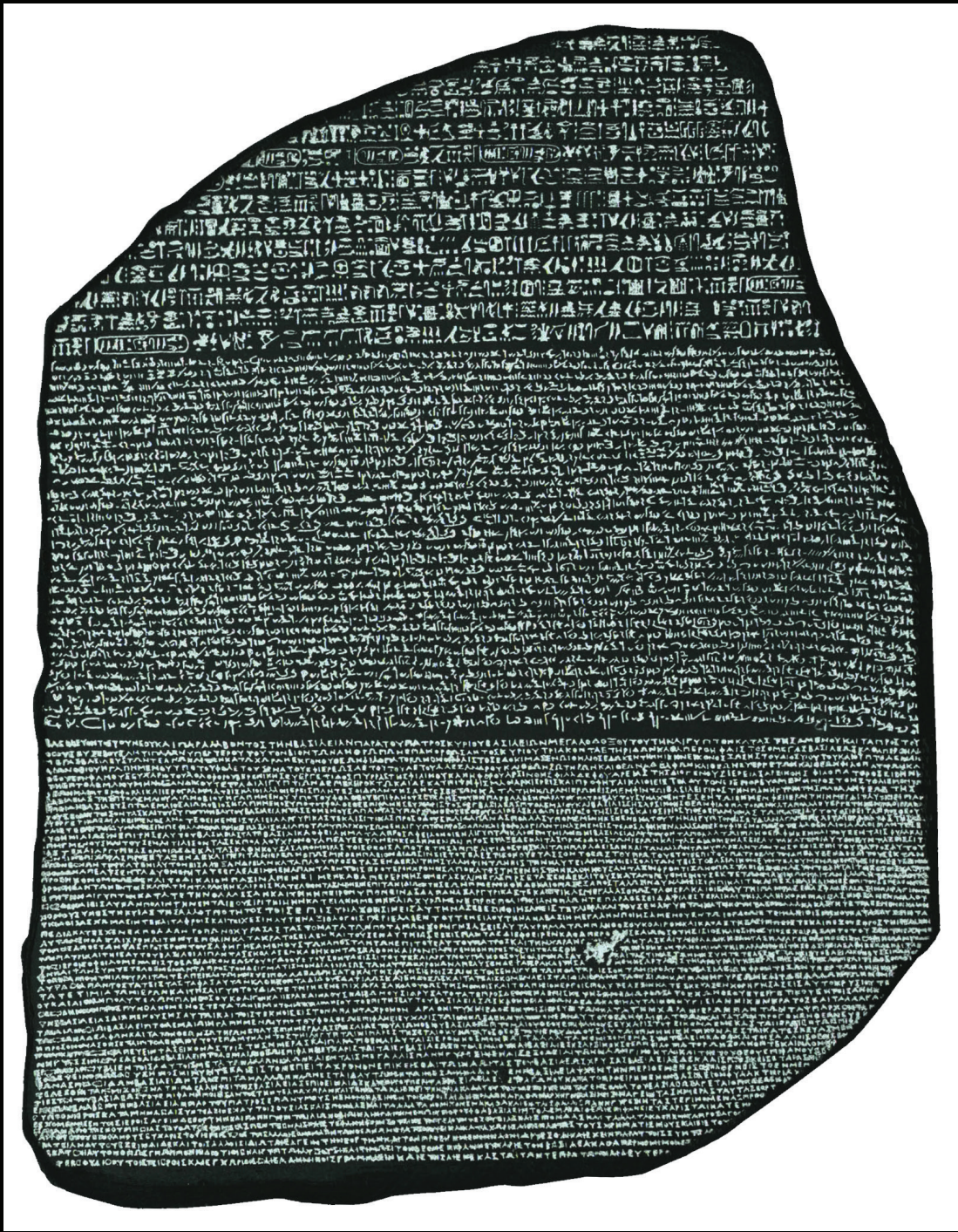

The Rosetta Stone, c. 197-196 B.C. From top-to-bottom, the concurrent hieroglyphic, demotic, and Greek inscriptions provided the key to the secrets of ancient Egypt.

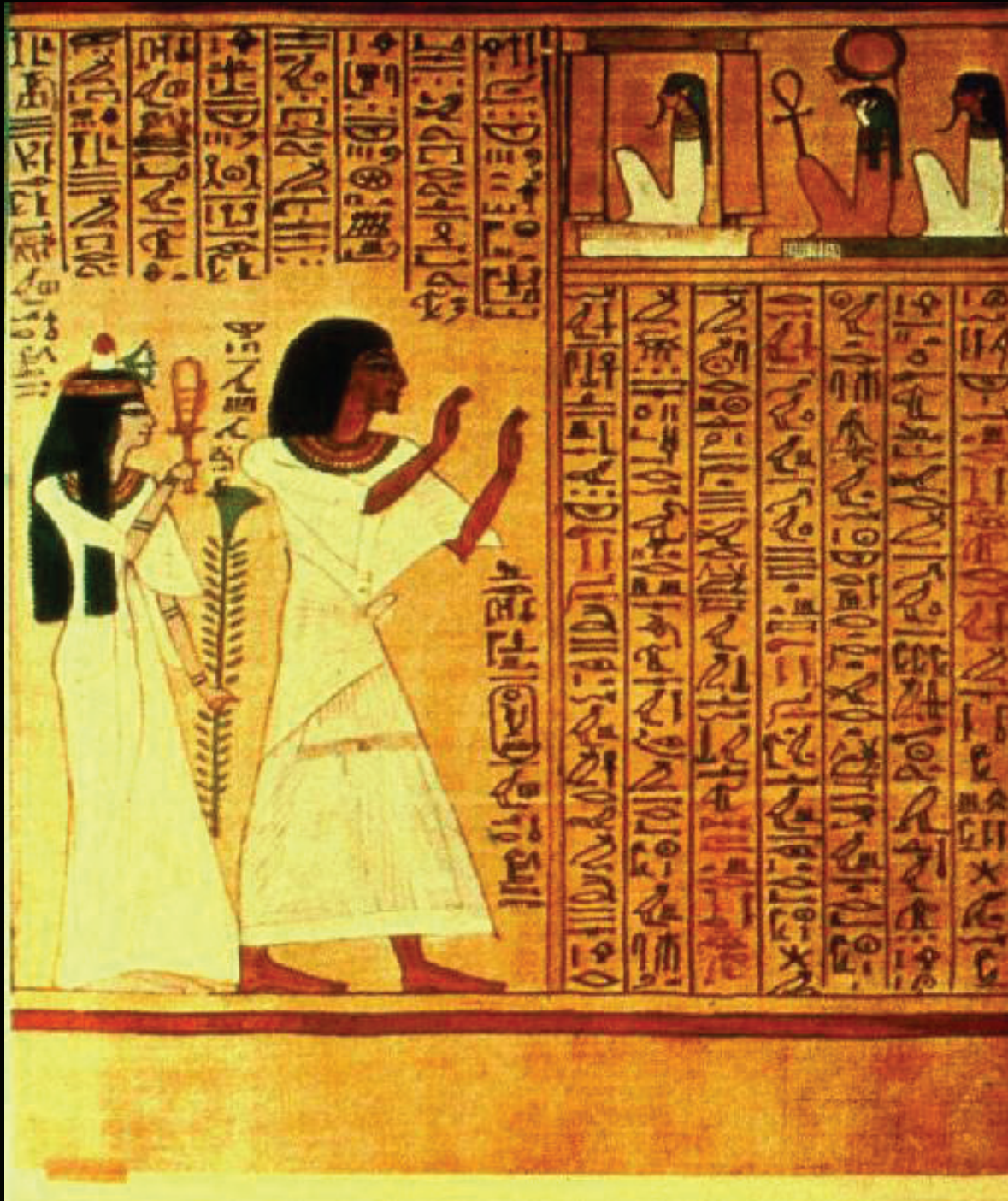

Detail from the Papyrus of Hunefer, c. 1370 B.C. Hunefer and his wife are worshipping the gods of Amenta. The sun god Ra bears an ankh symbol on his knee, and Thoth holds the udjat, the magical protective "sound eye" of Horus.

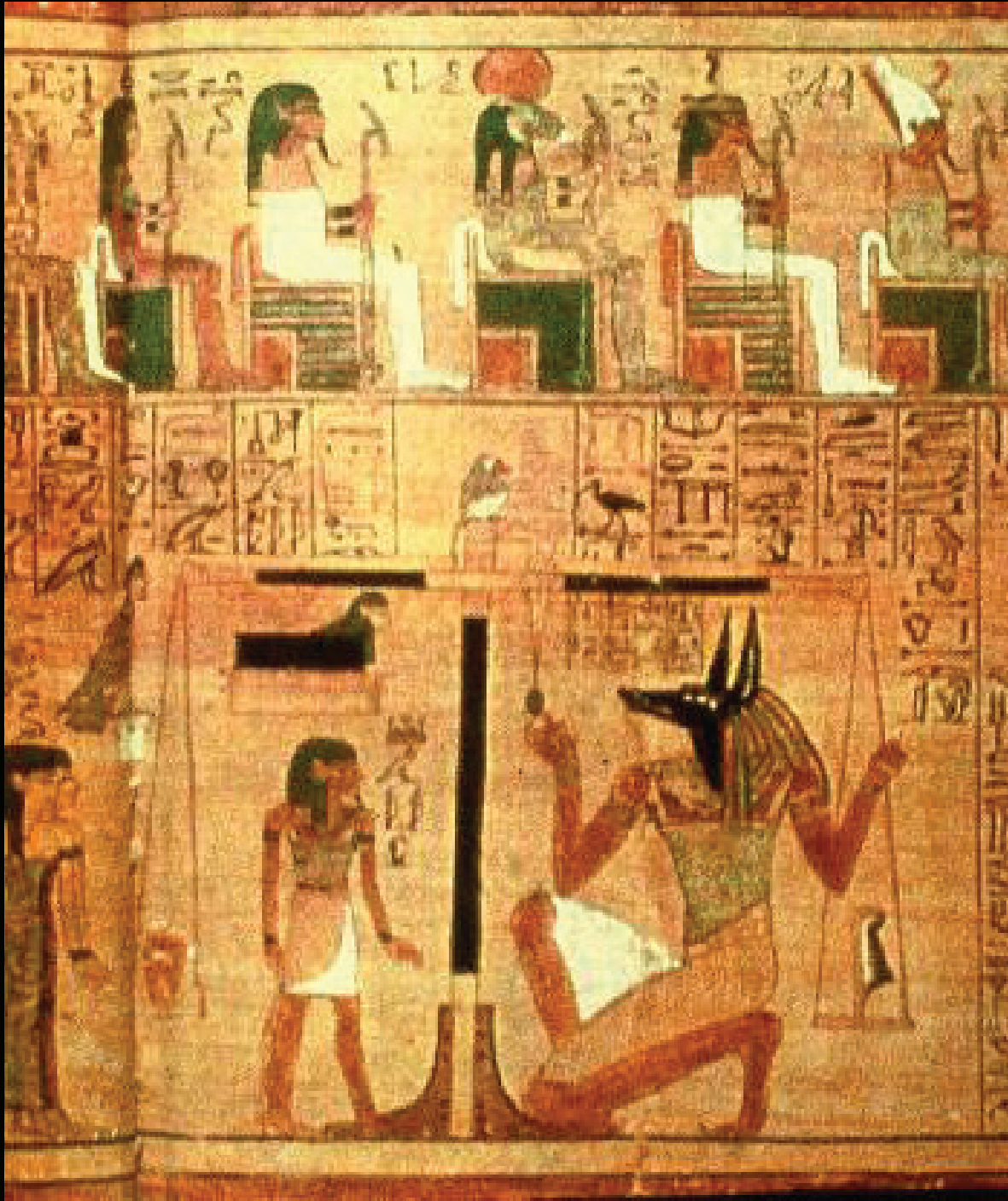

Vignette from the Papyrus of Ani, c. 1420 B.C. Ani, a royal scribe, temple accountant, and granary manager from Thebes, and his wife, Thuthu, arrive for his final judgment.

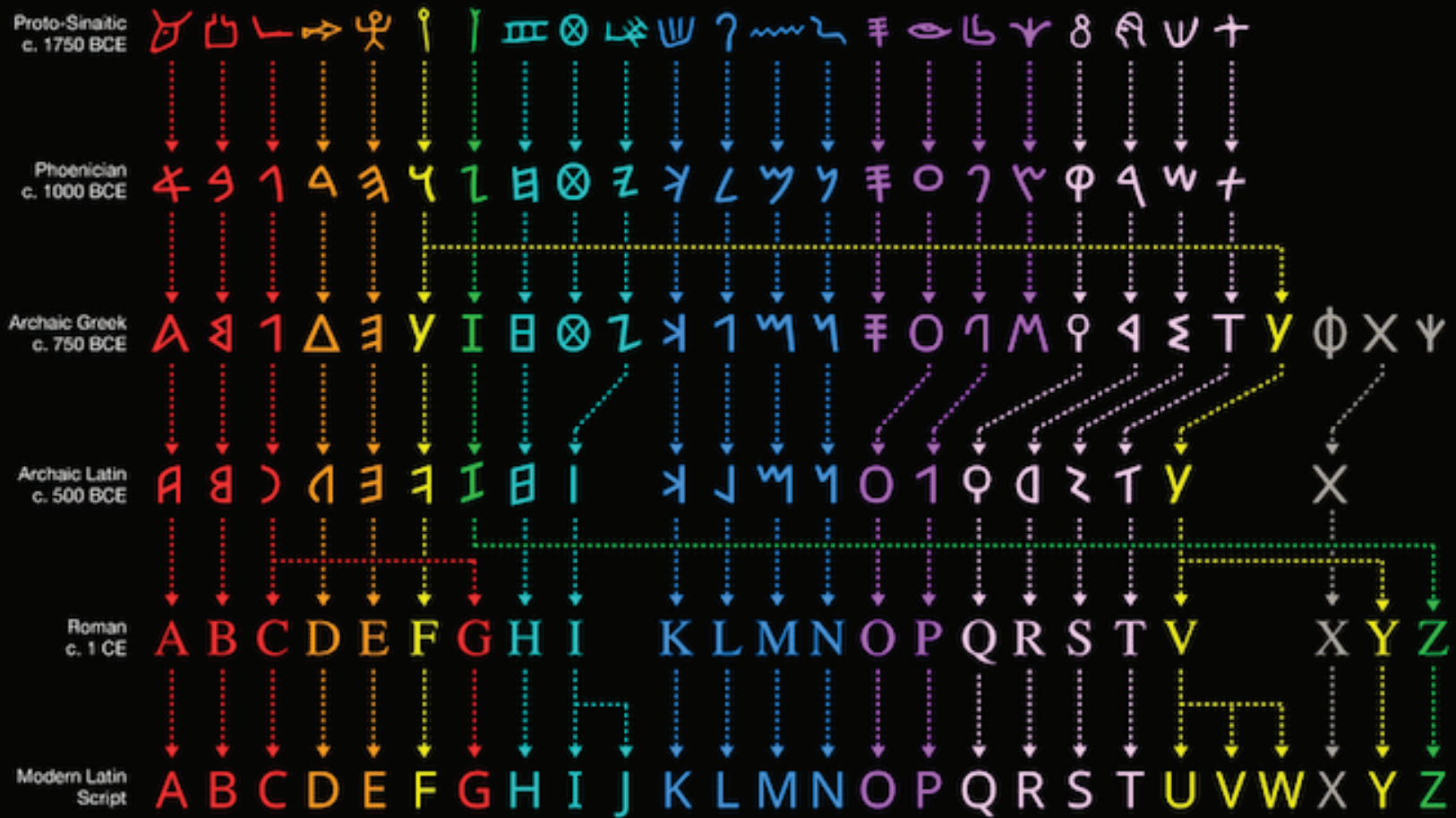

This diagram displays several evolutionary steps of Western alphabets.

The controversial theory linking early Cretan pictographs to alphabets is based on similarities in their appearance.

ΒΑΘΙΑ ΕΤΕΙΣΤΗ ΤΗΝ ΟΥΜΑΝΤΑ ΠΑΜΜΙΓΗ ΤΡΑΤΟΝ
ΓΟΝΤΡΕΤΗ ΚΑΙ ΚΙΣΚΑΜΑΦΑΤΟ ΔΕ ΚΥΜΑΙΝ-ΑΝΤΡΑΙΕΙΝ
ΙΑ ΚΑΤΑ ΕΚΑΔΑ ΔΟΜΩΝ ΕΙΡΙΑΙΤΕ ΝΑ ΕΞΕΛΜΑΝ ΚΕΣΑΙΚΑ
ΤΑ ΜΕΝ ΗΛΙΚΑ ΛΛΕΚΑΤΕ Η ΒΑΝΝΕΑΝ ΠΟΛΥΤΑΝ ΑΡΟΝΝΑ ΕΞΕ
ΟΥ ΚΙΟ ΠΙΚΚΟΤΟ ΡΕΥΣΟΝ ΑΞΟΥ ΕΙΜΠΥΡΟΣ ΔΕ ΑΙΘΑΛΟ ΕΜ ΜΕΤΡΟΣ
ΑΓΡΙΛΙΕ ΑΜΑΤΙ ΜΕΞΕΙΣ ΤΟΝ ΟΕΝΤΑ ΔΕ ΑΛΓΗ ΕΣΤΑ ΠΕΡΕΙ ΔΙ
ΚΑΡΑΝ ΒΑΡΕΙΑ ΤΜΦΟΡΑ ΑΜΕ ΕΛΛΑΔΗ ΓΑΓΕ ΕΛΛΑΝΤΕ
ΜΗ ΚΕΤΙ ΜΕΛΛΕΤΕ ΕΤΓΝΥΤΕ ΜΕΝ ΤΕ ΤΡΑΟΝΙ ΠΛΑΝ
ΟΧΗΜΑ ΟΙ ΔΕ ΑΝΑΡΘΟΜΟΝ ΟΛΒΟΝ ΦΟΡΕΙΤΕ ΠΑΠΗΝΑ ΕΠΙΜΠΡΑΤΕΣ
ΕΚΗΝΑ ΕΜΗ ΔΕ ΤΙΣ ΜΕΤΕΡΟ ΥΓΕΜΟΙ ΤΟΝ ΗΕΙ ΕΑΤΤΕ ΠΛΟΥΤΟΥ ΔΕ
ΤΡΟΠΑΙ ΑΣΤΗ ΚΑΜΕΝΟΙ ΔΙΟ ΕΛΓΝΟΤΑΤΟΝ ΤΕ ΜΕΝ ΟΣΙ ΑΙΑΝΑ ΕΚΕΛΑ
ΔΗ ΕΑΝΗ ΗΙΟΝ ΑΝΑΚΤΑ ΕΤΜ ΜΕΤΡΟΙ ΔΕ ΠΙΚΤΥΓΕΟΝΙ ΤΟ ΔΑΝΤΥ ΠΙΚΡΟΤΟΙΣ
ΧΟΡΕΙΑΙΣ
ΑΛΛΑ ΚΡΥΣ ΕΟΚΙΟ ΑΡΙΝΑ ΕΞΑΝ ΜΟΥΣΑΝΝΕ ΟΤΕ ΥΧΗ ΕΜΟΙΣ ΕΛΟΕ ΕΠΙΚΟΥΡΟΣ
ΥΜΝΟΣ ΙΝΗ ΚΙ ΕΠΑΛΑΝΟ ΓΑΡ ΜΕΥ ΓΕΝΕΤΑ ΕΜΑΚΡΑΙΝΕ ΠΑΡΤΑ ΕΜΕΓΔΕ
ΑΓΕΜΑΝ ΡΥΑΝΑΝ ΕΞΙΝ Η ΒΑΧΔΟΝ ΕΙΛΛΟΣ ΕΡΗΦΛΕΓΑΝ ΕΛΛΑΙΤΕ ΑΙΟΣ ΠΙ
ΜΑΜΑΤΟ ΤΗ ΠΑΛΑΙΟΤΕΡΑΝΝΕ ΟΙ ΚΥΜΝΟΙ Κ ΜΟΥΣΑΝΑΤΙ ΜΑ ΕΓΥΔΕ ΟΥΤΕ
ΜΕΡΜΙ ΙΝΑ ΟΥΤΕ ΓΕΡΑ ΟΝ ΟΥΤΕ ΚΗ ΒΑΝΕΙΡ ΓΟΤΩΝ ΕΚΑΔΥΜΝΑΝ
ΤΟΤΕ ΕΔΕ ΜΟΥΣΟΠΑ ΔΑΙΟΝΥΜΑ ΕΤΟΥΤΟ ΥΕ ΔΕ ΑΡΕΥΚΑ ΑΝΤΗΡΑ Ε
ΑΕΜΑΝ ΚΗ ΡΥΚΑΝΑΙ ΠΤΑΚΡΟΦΑΝΑΝΤΕΙΝ ΟΝΤΑΙ ΥΓΓΑΣ ΠΡΑΤΟΣ
ΠΟΙΚΙΛΟΜΟΤΕ ΟΣΟΡΙΤΕ ΝΕΤΕ ΚΗ ΚΕΝ ΥΙΣ ΚΑΔΑΙΟΠΑ
ΜΕΡΜΑ ΕΝΤΕΡΟΝ ΤΟΝ ΚΑΝΑ ΕΙΤΑ ΑΓΗΑ ΕΤΕΡΑ ΜΟΥΣΑΝ

This excellent example of the Greek alphabet shows the symmetrical form and even visual rhythm that evolved. These qualities made the Greek alphabet the prototype for subsequent developments.

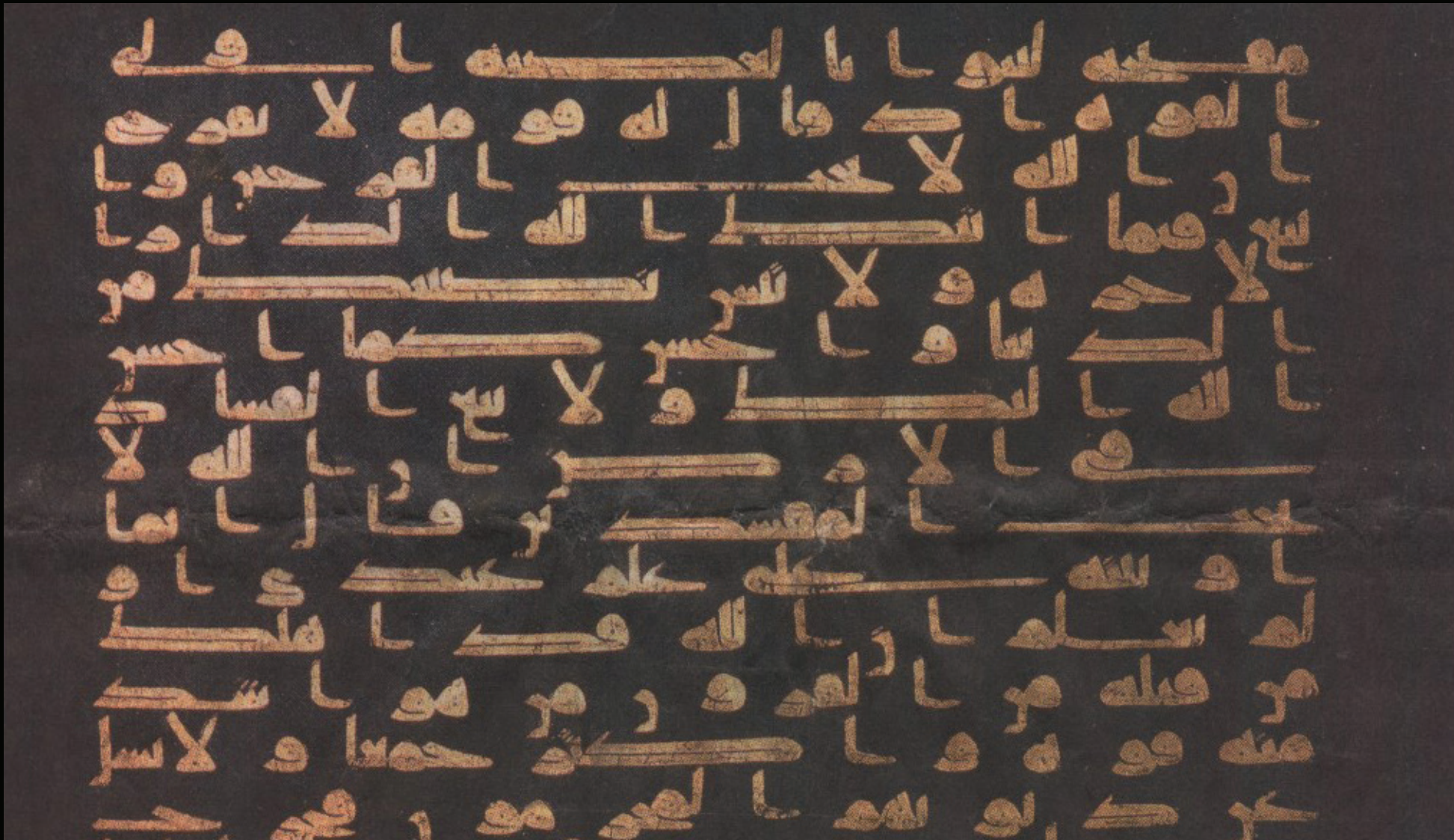

Kufic characters are bold, elongated, and angular; their aesthetic properties being widely admired.

ثالث و
عشرون

هُمْ مُهْتَدُونَ وَمَالِيَ لَا أَعْبُدُ الَّذِي فَطَرَنِي وَإِلَيْهِ تُرْجَعُونَ
 اتقان راه یافته اند و صحت مرا برستیم انرا از پروردگار و بوی او بازگرد
 اتَّخِذْ مِنْ دُونِهِ إِلَهًا إِنْ يَرِدْنا لِرَحْمٰنٍ بَصِيرًا لا تُغْنِ عَنِّي شَفَاعَتُهُمْ
 انرا فراهم بخزوی خدايان الزوائد خداي من رحمتي دلت نموده از من در دعوات انان
 شَيْئًا وَلَا يُنْقِذُونِ لِإِنِّي إِذَا لَفِيَ ضَلالٍ مُبِينٍ لَأَتِيَّ مَنِّي بَرَكِيُّ
 صحت و زود ندهم برستيد من نگاه در گمراهي استگار در سستار دردم بخداوند
 فَاسْمَعُونَ قِيلَ ادْخُلِ الْجَنَّةَ قَالَ يَا لَيْتَ قَوْمِي يَعْلَمُونَ بِمَا غَفَرَ
 پس بشنويد گفتند دراي در ممت گفت که غلبي قوم من مبدان ما که امر زيد
 لِي رَبِّي وَجَعَلَنِي مِنَ الْمَكْرُمِينَ وَمَا أَنْزَلْنَا عَلَى قَوْمِهِ مِنْ
 مراط اولين و کرد اندهم انرا امي شده كان و نخواستارم بر قوم او از
 بَعْدِهِ مِنْ جُنْدٍ مِنَ السَّمَاءِ وَمَا كُنَّا مُنْزِلِينَ إِنْ كُنْتَ إِلَّا صَيِّحَةً
 پس او پنج نكري از آسمان و مستند و مستند بود عقوبت موزايدي
 وَاحِدَةً فَإِذَا هُمْ خَامِدُونَ يَا حَسْرَةَ عَلَى الْعِبَادِ مَا يَأْتِيهِمْ مِنْ
 بت پس نگاه ایشان مرده كان بوي درين برنده كان ناهات ترا پنج
 رَسُولٍ إِلَّا كَانُوا بِهِ يَسْتَهْزِئُونَ الْمُرِيرَ وَالْمُرَاهِكَةَ قَبْلَهُمْ مِنْ
 بهتست مگر بودند بان استهزا ميگردد ابا نديتم چند جاى كردم پنج از انان از
 الْقُرُونِ أَنَّهُمْ إِلَيْهِمْ لَا يَرْجِعُونَ وَإِنْ كُنَّا جَمِيعٌ لَدَيْنا
 فرينا به مستي انان بوي است ان باز نرند و مستند همه انان مكرم مع عدد مريد
 مُخْضَرُونَ وَآيَةٌ لَهُمُ الْأَرْضُ الْمَيْتَةُ أَحْيَيْنَاهَا وَأَخْرَجْنَا مِنْهَا
 حاضر شده كان وقت ز دير مالت ز از من مرده زنده كردم انرا و برون آوردم از ان
 حَبًا فَمِنْهُ يَأْكُلُونَ وَجَعَلْنَا فِيهَا جَنَّاتٍ مِنْ جَبَلٍ وَاعْنَابٍ
 دانه با پس از ان نموزند و او بدم در زمين بوستند از حرماتمان و انگور
 وَفَجَّرْنَا فِيهَا مِنَ الْعَيْونَ لِيَأْكُلُوا مِنْ ثَمَرِهِ وَمَا عَمِلَتْهُ أَيْدِيهِمْ
 در وان كردم در ان الرضياها نموزند از بهوه و انگر دومت دستهاي است ن
 أَفَلَا يَشْكُرُونَ سُبْحَانَ الَّذِي خَلَقَ الْأَزْوَاجَ كُلَّهَا مِمَّا تُثْبِتُ
 ايا شكر ميكنند باست انكه او بدم صفتها همه انان از بركه مبر و بانه
 الْأَرْضِ وَمِمَّا لَا يَعْلَمُونَ وَآيَةٌ لَهُمُ اللَّيْلُ نَسْلَخُ مِنْهُ
 زمين و از نفس است ان و از ان نموزند وقت ز حرمات دست در دست از ان
 النَّهَارَ فَإِذَا هُمْ مُظْلَمُونَ وَالشَّمْسُ تَجْرِي لِمُسْتَقَرٍّ أَذَلِكَ تَقْدِيرُ



ع

This manuscript is written in the cursive Naskhi style of Arabic calligraphy.

The Chinese writing system is a purely visual language. It is not alphabetical, and every symbol is composed of a number of differently shaped lines within an imaginary square.

意能殼成就在地如在天一樣
我們需用的糧食求你今日給
我求你免我的債照我免人債
的樣兒不要由我入迷願你榮
我出惡爲的是邦國權勢榮耀



Natural fibers are soaked in a vat of water and beaten into a pulp. A screen-bottomed, framelike mold is dipped into the pulp solution, taking just enough onto the mold for the sheet of paper.



Chinese woodblock print, c. A.D. 950.

A prayer text is placed below an illustration of Manjusri, the Buddhist personification of supreme wisdom, riding a lion.

此菩薩山中文殊師利大聖真儀變
 現多般威靈巨測久成正覺不
 捨大悲隱法界身示天人相與萬
 菩薩住清涼山攝化有緣利益弘
 廣思惟憶念增長吉祥禮敬稱揚
 能滿諸願普勸四眾供養歸依當
 來同證菩提妙果
 文殊師利童真菩薩五字心真言
 阿 囉 跋 左 履
 文殊師利大威德法寶真感心陀羅尼
 唵 引 阿 味 囉 吽 引 佉 左 略
 對此像前隨分供養真心境寧
 注課持迴施有情同歸常樂

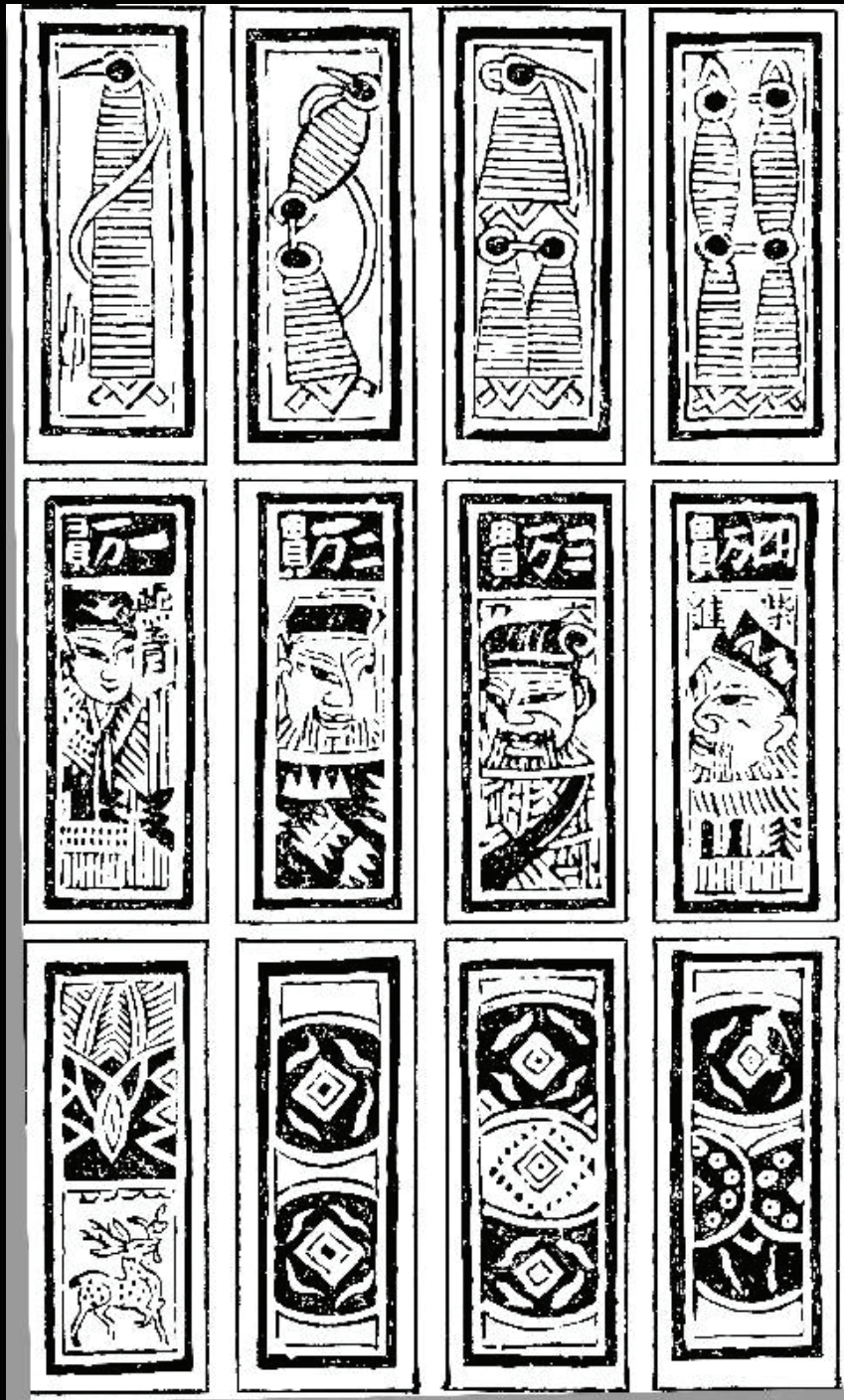

Chinese playing cards, undated. Many of the design conventions used here—numerical sequences of images signifying the suits and the depiction of royalty—survive in playing cards to this day.

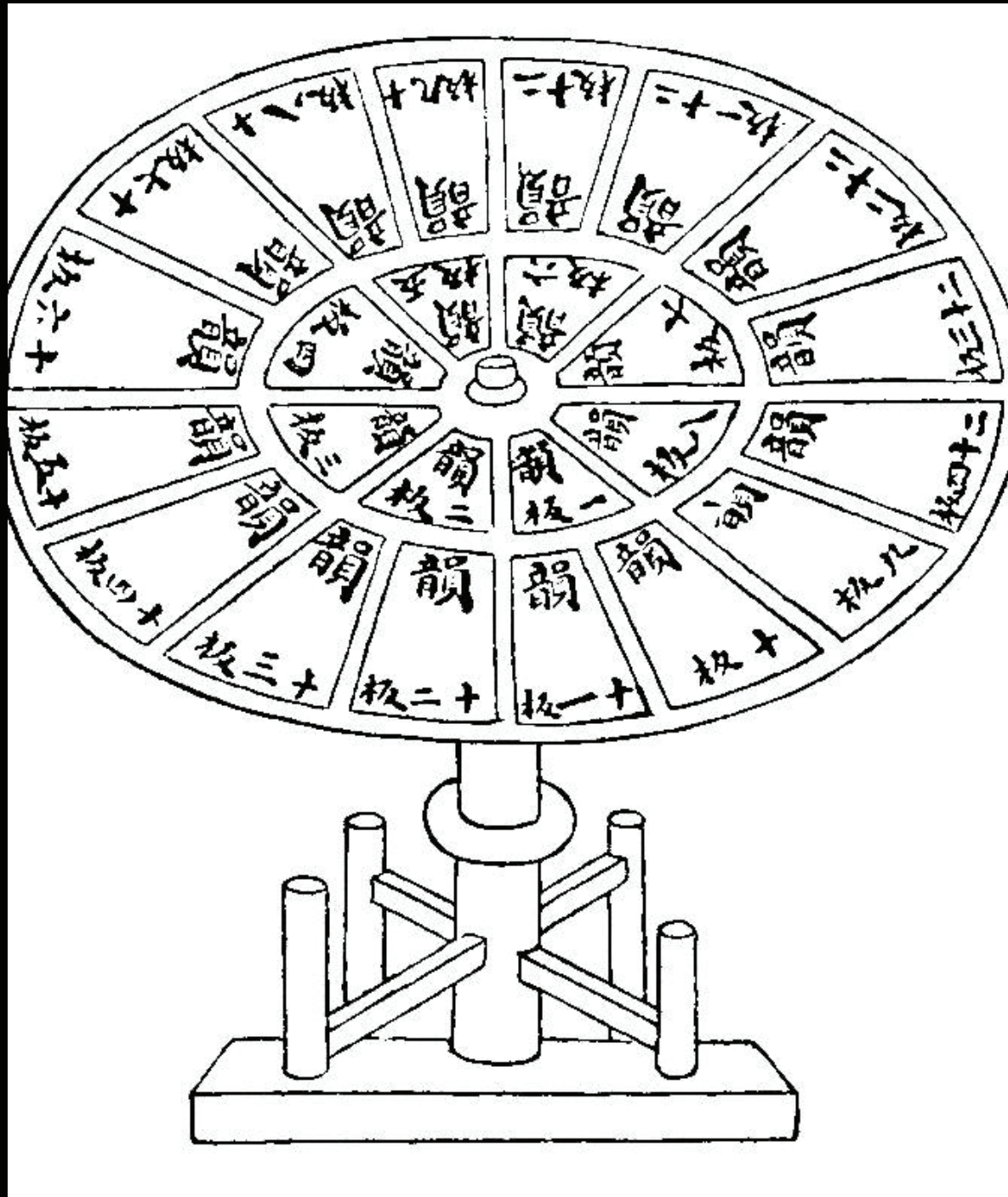

Woodblock image of a revolving typecase, c. A.D. 1313. This quaintly stylized illustration shows the revolving case designed to make typesetting more efficient.



Jack of Diamonds, woodblock playing card, c. 1400. The flat, stylized design conventions of playing cards have changed little in over five hundred years.

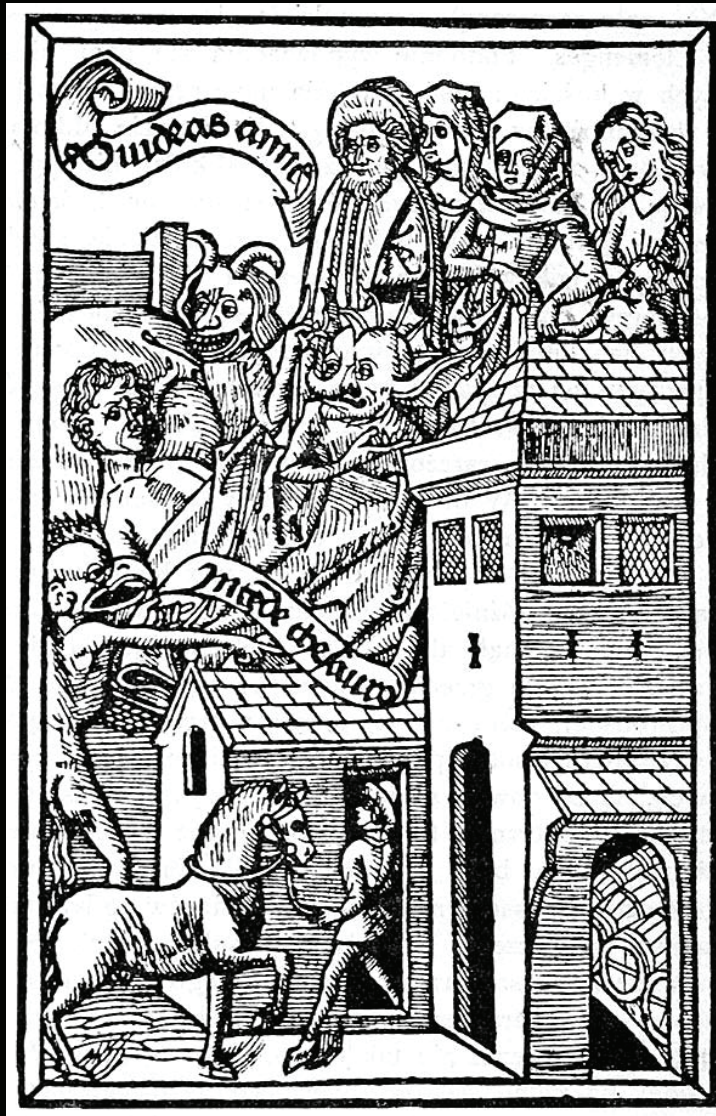

Temptatio dyaboli de Auaritia magis se-
 cularis et carnalis infestans que est nimia occu-
 patio temporalium atque exteriorum cum uxores et caros
 carnales seu corporales diuitias atque alia que magis in vita
 sua dilexerunt pro que dyabolo hominum maxime uexat in fine
 dicitur O miser tu iam relinques omnia temporalia que sollicitu-
 dyaboli et laboribus maximis sunt congregata etiam uxorem
 proles et consanguineos caros carissimos et omnia alia hu-
 ius mundi desiderabilia quorum te societati adhuc interesse
 et magnum foret solacium propter quod magnum boni occasio.
 Hec et similia dyabolo hominum in extremis de auaritia
 prouocat ut sic pro amore et cupiditate terrenorum auertat
 amore dei et propria salute. Unde singulariter notandum
 quod maxime cauere debet ne cuius moriente anima corporales
 uxor liberi diuitie et alia temporalia ad memoria reducant
 nisi in quantum illud infirmi spiritualis sanitas posulet aut
 requirat quod alias maxime periculosum esset tunc sit ab his que
 spiritus et salutis sunt quibus maxime tunc omnibus uicibus interioribus
 et exterioribus intendendum est reuocaretur ad ista
 misera temporalia et carnalia tunc cum maxima so-
 licitudine a memoria et mente remouenda in quibus
 certe tunc occupati est ualde periculosum.

Pages from the *Ars Moriendi*. A montage juxtaposes the deathbed scene with the subject's estate. One demon urges, "Provide for your friends," while the other advises, "Attend to your treasures."



The book of Durrow, opening page the Gospel of Saint Mark, 680 A.D. Linked into a ligature, and I and N become an aesthetic form of interlaced threads and coiling spiral motifs.

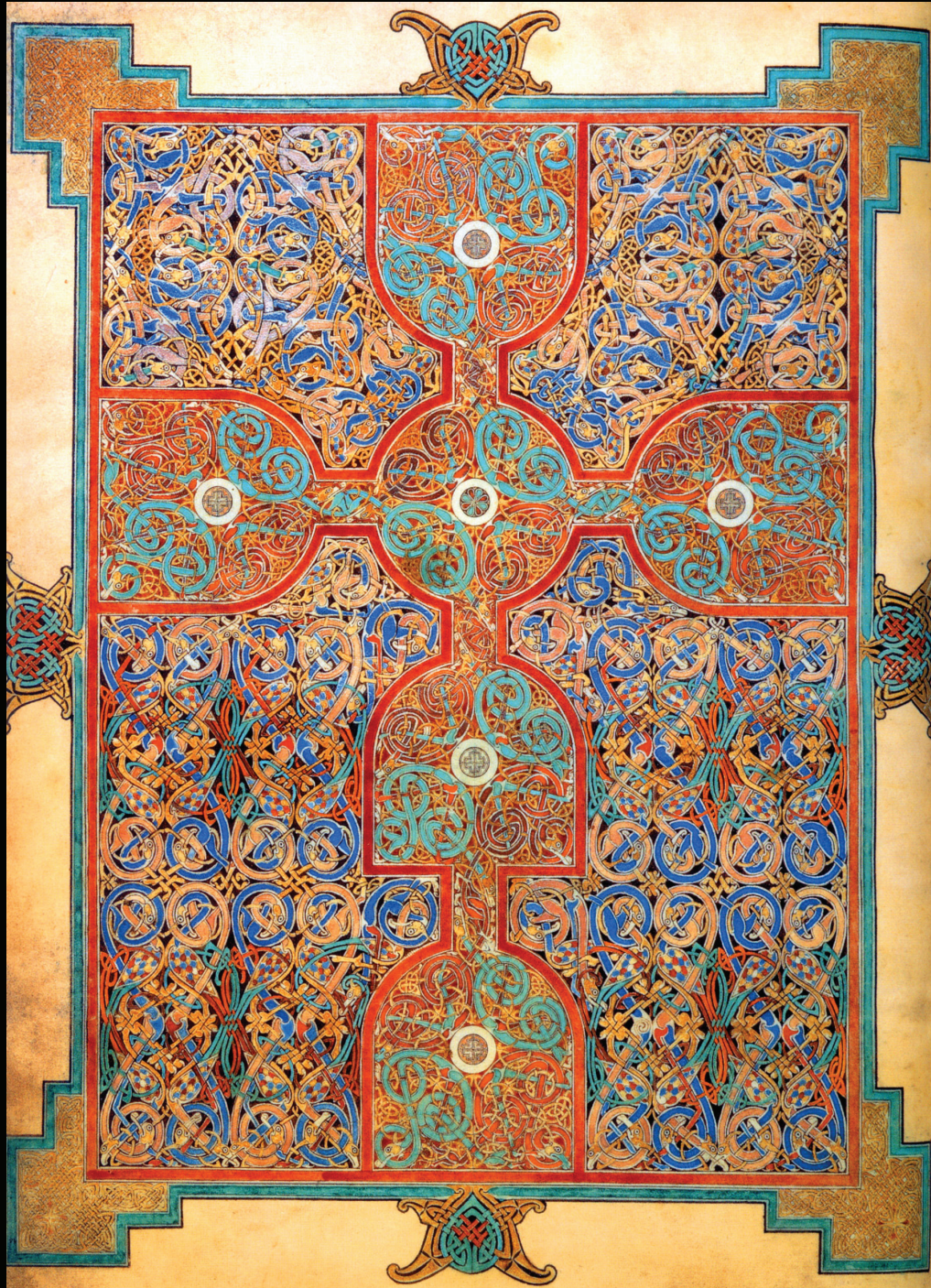

The Lindisfarne Gospels, carpet page facing the opening of Saint Matthew, 698 A.D.



The Book of Kells, the Chi-Rho page 794-806
A.D.

Omnis quod datur mihi pater a me
uenis. Et cum quod a me uenit non uenit
foras. **Q**uoluntatem meam
Quia discendi de caelo non uenit
sed uoluntatem eius qui me misit.
Hoc est autem uoluntas eius qui
misit me pateris ut omne quod dedit
mihi non perdam. Et ego sed resuscitabo
illum in nouissimo die. **H**oc est enim
uoluntas patris mei qui misit me ut om-
nis qui uenit filium et credit in eum ha-
beat uitam aeternam. Et resuscitabo
eum in nouissimo die. **M**urmurabant ergo iudei de illo
quia dixisset. Et osumpauis quide-
m caelo discendi. Et dicebant uoluit hic
est filius ioseph cuius uos nouimus
patrem et matrem quomodo ergo dicit

The Book of Kells, text page with ornamental initials, 794-806 A.D.

Cum esse sedes pontificalis
mater eius maria
ioseph. antequam
conuenirent inuenta
ē. in utero habens

Caroline minuscules from the ninth century A.D.

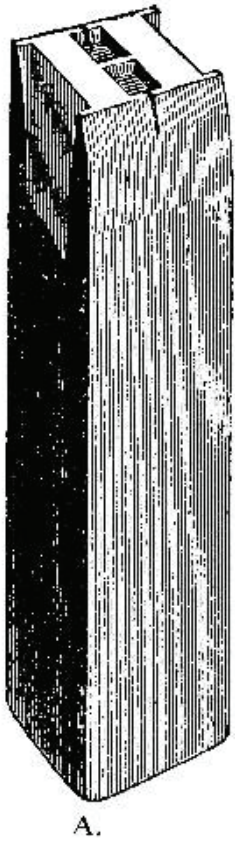

A.

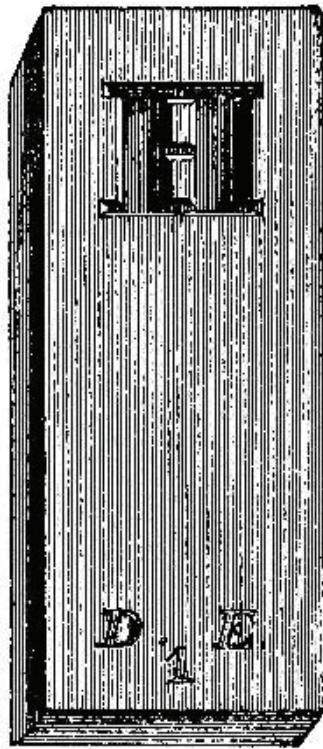

B.

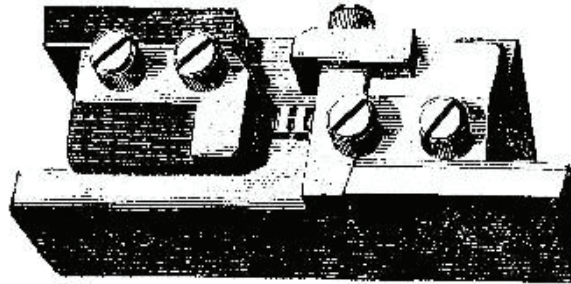

C.

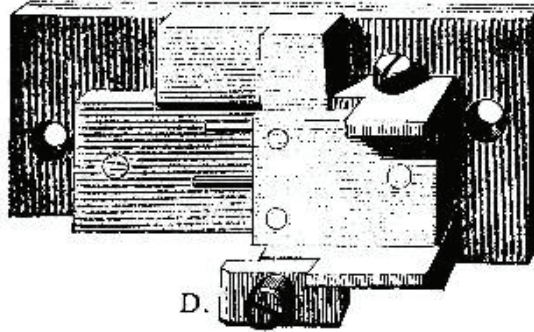

D.

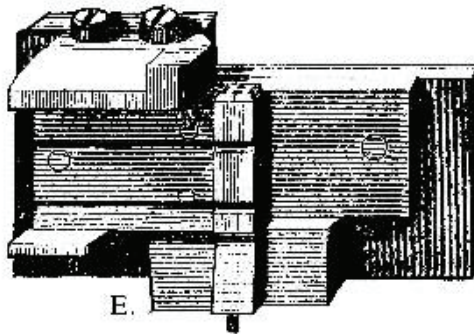

E.

These early-nineteenth-century engravings illustrate Gutenberg's system for casting type.

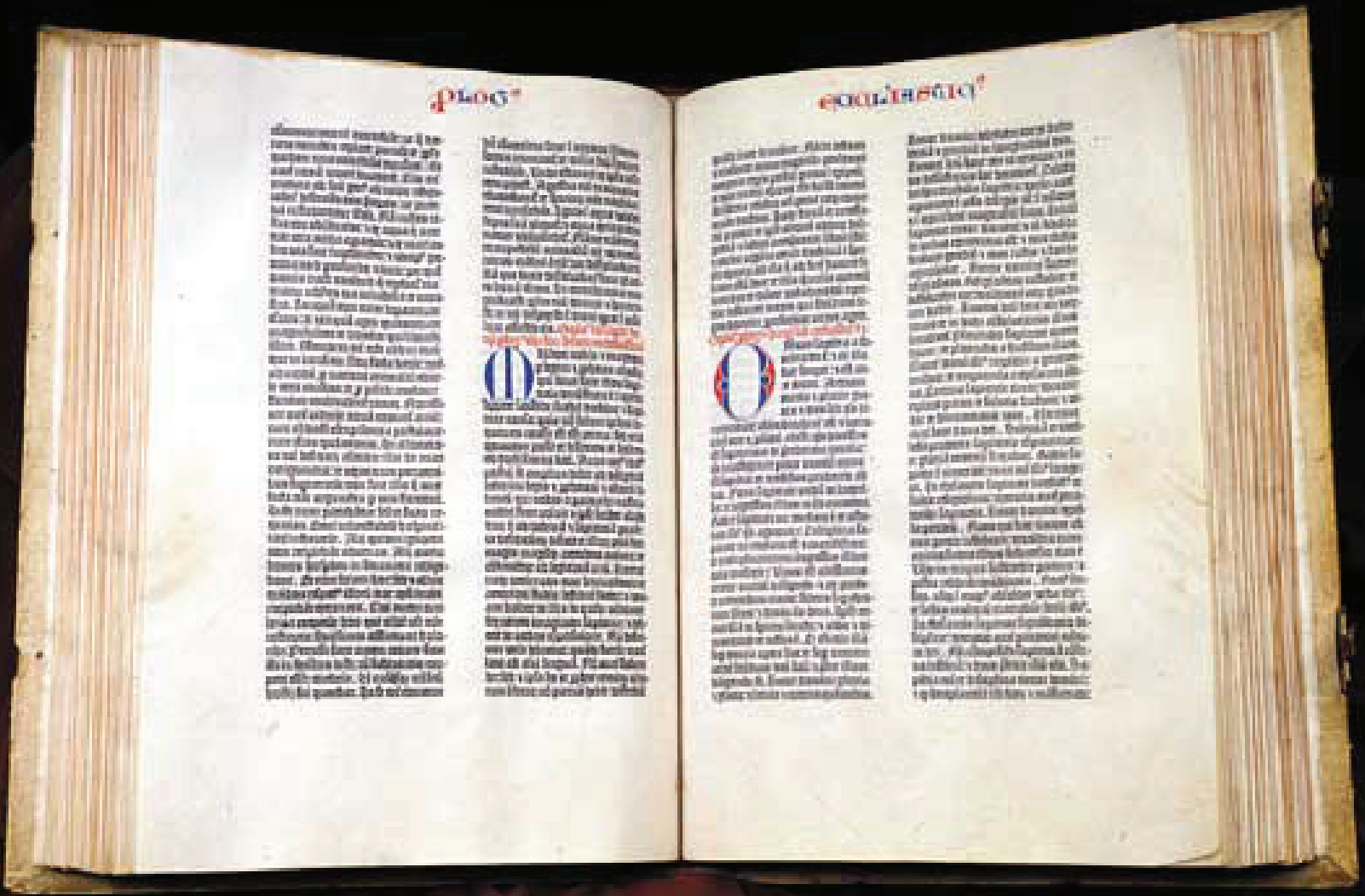

Johann Gutenberg, pages from the 42-Line Bible, 1450-55. The superb typographic legibility and texture, generous margins, and excellent presswork make this first printed book a canon of quality that has seldom been surpassed. An illuminator added the red and blue headers, initials, and text by hand.

Incipit epistola sancti ieronimi ad panthym
presbiteri de omnibus divinis libris.

Capitulum primum

Hater ambrosius tuam michi munuscula perferens - detulit simul et suavissimas litteras: que a principio a mihi gratia fore probare iam fidei et veteris amicitie precebat. Hec enim illa necessitudo est et christi gloriose copulata: qua non utilitas rei familiaris - non presentia tantum corporis - non subdola et palpas adulatio: sed dei timor et divinarum scripturarum studia conciliant. Legimus in veteribus historiis quosdam lustrasse provincias - novos adisse populos - maria transisse: ut eos quos se libris noverat: coram se viderent. Sic pitagoras memphiticus vates - sic plato egyptum - et architam tarentinum - eamque ora yralie - que quondam magna grecia dicebat: laboriosissime peragravit: ut qui athenis magister erat - et potius cuiusque doctrinas ad academie signum profectus - heret peregrinus atque discipulus: malens aliena verere discere: quam sua impudenter ingerere. Denique cum litteras quasi toto orbe fugientes persequitur: captus a piratis et venudatus - tyranno crudelissimo paruit - ductus captivus vincit et securus: tamen quia philosophus: maior emente se fuit - ad tyrannum - lacteo eloquentie fonte manantem - de ultimis hispanie galliarumque finibus quosdam venisse nobiles legimus: et quos ad contemplationem sui roma non traxerat: unius hominis fama perduxit. Habuit illa etas inaudiam omnibus seculis - celebrandumque miraculum: ut verum tantam

ingressi: aliud egera verbum queerere. Apollonem siue ille magister ut vulgus loquitur - siue phis ut pitagorici tradunt - itavit plas - presertim caucasi - albanos - sacras - mallagetas - opulentissima india penetravit: et ad egerentum lacillimo phytou amure transivisse puenit ad braguanas: ut hyarem in throno sedente aureo - et de caucasi fonte potantem - inter paucos discipulos - de natura - de moribus ac de cursu diei et siderum audiret doctorem. Unde yelanitas - babylonios - chaldeos - medos - assirios - parthos - syrophenticos - arabes - palestinos - reclusus ad alexandriam - peregit ad ethiopianam: ut gignosiphitas et famosissimam solis mensam videret in tabulo. Invenit ille vir ubique quod disceret: et semper proficiens - semper se melior fieret. Describit super hoc plenissime octo voluminibus - phylotratius. **cap. 11.**
Quid loquar de seculi hominibus? cum apostolus paulus vasa electionis - et magister gentium - qui de conscientia tanti in se hospitii loquebatur - dicens - An experimeatum queris eius qui in me loquitur cultus - post damascum arabiam lustratam - ascendit iherosolimam ut videret petrum et manserit apud eum diebus quindecim. Hic enim misterio ebdoyradis et agdoadis: futurus gentium predicator instruendus erat. Quis enim post annos quatuordecim assumpto barnaba et tyro - reposuit cum apostolica evangelium: ne forte in vacuum curret aut cucurisset? Habet nescio quid latentis energie vite vocis actus: et in aures discipuli de auctoris ore translata: forte sonat. Unde et electus cum rodi regularet - et legeret illa demosthenis

Pro epistola sancti ieronimi ad panthym presbiteri de omnibus divinis libris. Capitulum primum. Hater ambrosius tuam michi munuscula perferens - detulit simul et suavissimas litteras: que a principio a mihi gratia fore probare iam fidei et veteris amicitie precebat. Hec enim illa necessitudo est et christi gloriose copulata: qua non utilitas rei familiaris - non presentia tantum corporis - non subdola et palpas adulatio: sed dei timor et divinarum scripturarum studia conciliant. Legimus in veteribus historiis quosdam lustrasse provincias - novos adisse populos - maria transisse: ut eos quos se libris noverat: coram se viderent. Sic pitagoras memphiticus vates - sic plato egyptum - et architam tarentinum - eamque ora yralie - que quondam magna grecia dicebat: laboriosissime peragravit: ut qui athenis magister erat - et potius cuiusque doctrinas ad academie signum profectus - heret peregrinus atque discipulus: malens aliena verere discere: quam sua impudenter ingerere. Denique cum litteras quasi toto orbe fugientes persequitur: captus a piratis et venudatus - tyranno crudelissimo paruit - ductus captivus vincit et securus: tamen quia philosophus: maior emente se fuit - ad tyrannum - lacteo eloquentie fonte manantem - de ultimis hispanie galliarumque finibus quosdam venisse nobiles legimus: et quos ad contemplationem sui roma non traxerat: unius hominis fama perduxit. Habuit illa etas inaudiam omnibus seculis - celebrandumque miraculum: ut verum tantam

Johann Gutenberg, pages from the 42-Line Bible, 1450-55.



A reproduction of Gutenberg's press.

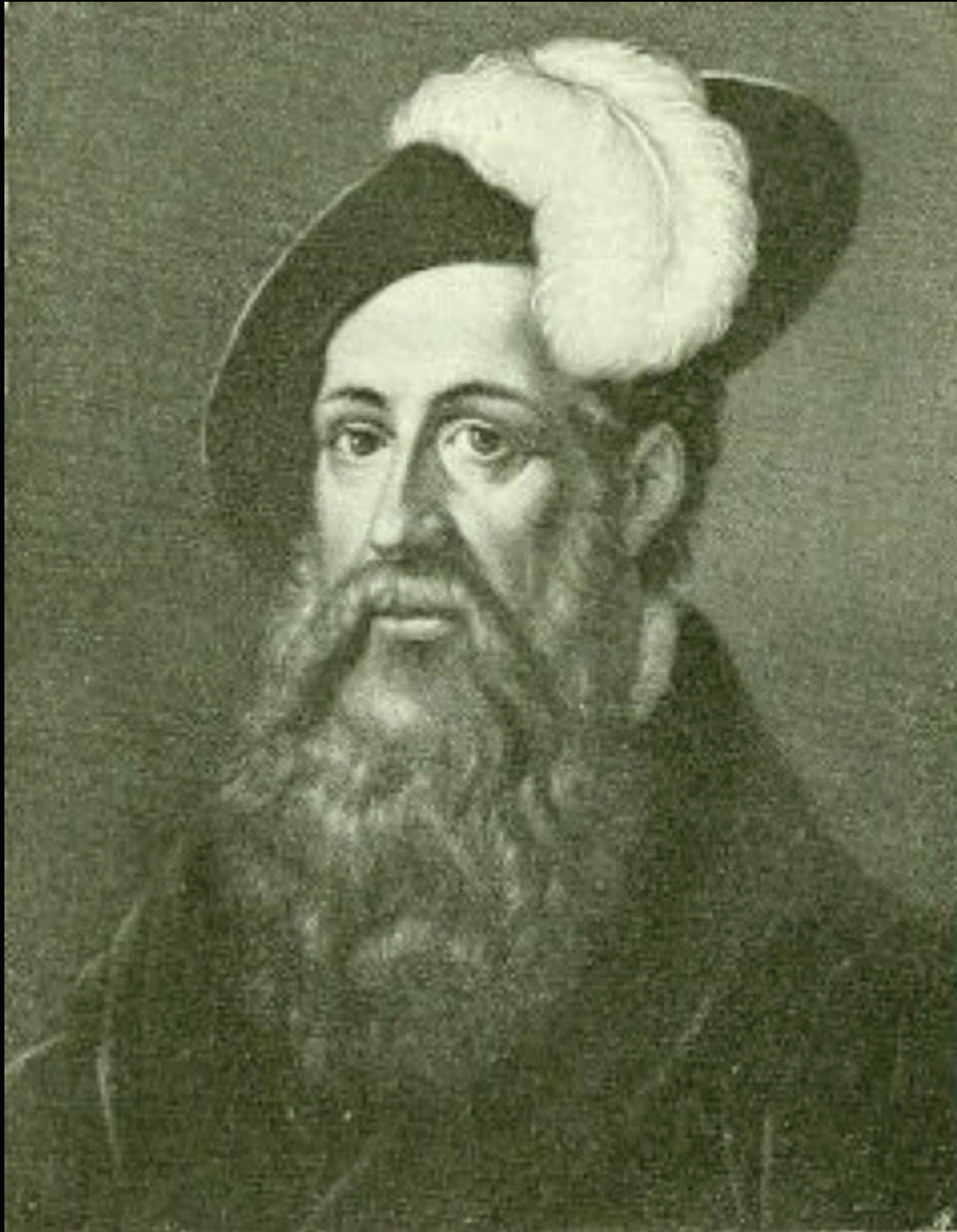

Johann Fust







Nicolas Jenson 1420-1480



Jenson's typographer's mark

Attributed to Nicolas Jenson, mark for the Society of Venetian Printers, 1481. One of man's oldest symbols, the orb-and-cross motif is found in a chamber of Cheops's pyramid at Giza, where it was hewn into stone as a quarry mark.

Hæc igitur inspiciēs diuinus ille uir mœnibus ferreis & īuiolabili
a cæteris gētibus separe nos uoluit: quo pacto facilius corpore a
īmaculatos lōgeq; ab huiuscemodi falsis opinioībus remotos for

Nicolas Jenson, typography from Eusebius's *De Praeparatione Evangelica*, 1470. A new standard of excellence was established with wider letterforms, lighter tone, and a more even texture of black strokes on the white ground.



Aureus hic liber est : non est preciosior ulla
Gēma kalendario : quod docet istud opus.

Aureus hic numerus : lune : solisq; labores
Monstrantur facile : cunctaq; signa poli :
Quotq; sub hoc libro terre per longa regantur
Tempora : quisq; dies : mensis : & annus erit .
Scitur in instanti quęcunq; sit hora diei .
Hunc emat astrologus qui uelit esse cito .
Hoc Ioannes opus regio de monte probatum
Composuit : tota notus in italia .
Quod ueneta impressum fuit in tellure per illos
Inferius quorum nomina picta loco .

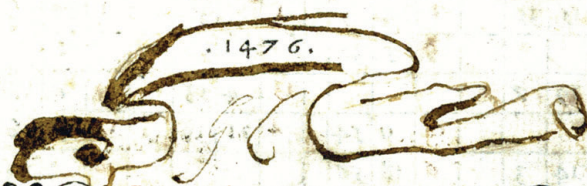

Bernardus pictor de Augusta
Petrus loslein de Langencen
Erhardus ratdolt de Augusta

Erhard Ratdolt, Peter Loeslein, and Bernhard Maier, title page for *Calendarium*, by Regiomontanus, 1476. The title and author are identified in verse describing the book. The date and printers' names in Latin appear below.

INSTRUMENTVM VERI
MOTVS LVNAE.
MINVE.

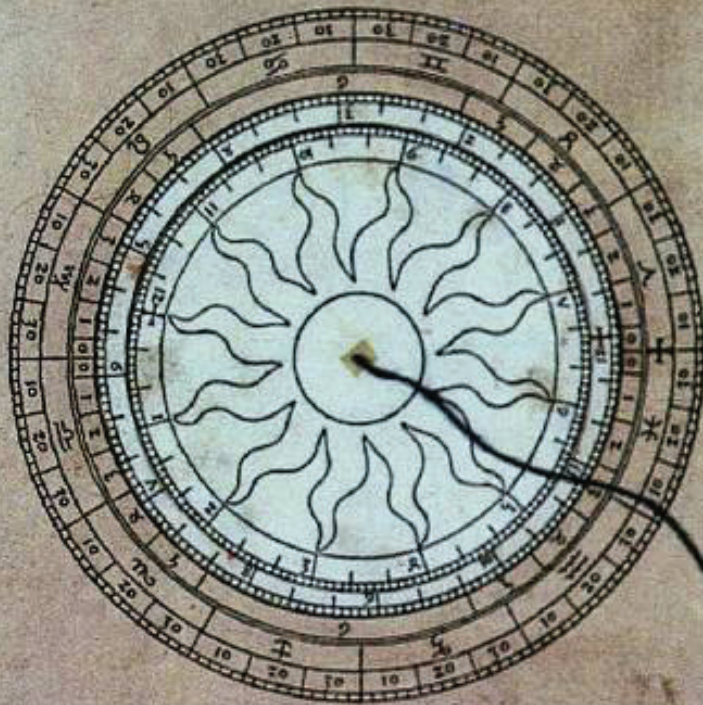

. A D D E .

DE AVREO NUMERO.



Vreū numerum cuiusvis anni sic iuenies
Vide quotus sit annus propositus a primo
anno Christi domini. que numerus si offen-
des i tabella hic apposta: aureus numerus est
13. si non: numero proximo minori illic
expilto da 13; sequenti 18; et iterum succedenti 13. sic qd
deinceps donec pducere ad numerum anni propositi. hoc est: sin-
gulis annis singulos aureos numeros accomoda incipiendo ab
anno qui apparet in tabella: et a 13 pmo scilicet i serie aurei nu-
meri subscripta. na ubi an? tu? sede iueniet: illic habebis aureū
numerum quęsitum. Sub quo etiam continuo clavis festoꝝ mobi-
lium comūnis apparebit.

13	18	13	18	13	18	13	18	13	18	13	18	13	18	13	18	13	18
12	17	12	17	12	17	12	17	12	17	12	17	12	17	12	17	12	17

DE CYCLO SOLARI ET
LITTERA DOMINICALI.



Vmerus cycli solaris simili computo deprehendit
p sua tabella hic posita. Nam si numerus ani
ppositi scriptus est in ea tabella: cycli sola-
ris numerus est 28. Si non est illic expilto:
da proximo minori ibide scripto 28; sequenti
1: ac rursus succedenti 7. sic qd deinceps queadmodū de
aureo numero precipiebatur: donec ad annum ppositū
puenies. nam ubi talis annorū supputatio desinet: illic in serie
cycli solaris subscripta numerū cycli solaris quęsitū agnosces.
Sub eo autem numero cycli solaris cōtinuo habebis litterā do-
minicalem anni tui. que si unica occurrat: annum esse conu-
nem intelliges. si duplex: bissextilem. Prior id est superior
ad festum usq; Matthei apostoli utilis erit. Inferior autē ad re-
liquam anni partem accomodabitur.

Erhard Ratdolt, Peter Loeslein, and Bernhard Maier, pages from *Calendarium*, by Regiomontanus, 1476. The two top circles are printed on heavy paper, cut out, and mounted over the larger woodcut with tape and a string.

Præclarissimus liber elementorum: Euclidis per scripti:
 cæcissimi: in artem Geometriæ incipit quæsoleticissime:



Punctus est cuius pars non est. **L**inea est longitudo sine latitudine cuius quidam extremitates sunt duo puncta. **L**inea recta est ab uno puncto ad alium brevissima extremitates suas utriusque eorum recipiens. **S**uperficies est quæ longitudinem et latitudinem habet: cuius termini quidam sunt linee. **S**uperficies plana est ab una linea ad aliam extensa: extremitates suas recipiens. **A**ngulus planus est duarum linearum alterius terminus prout: quæ extensio est super superficiem applicatioque non directa. **Q**uando autem angulum terminat due linee recte rectilineus angulus nominatur. **Q**uando recta linea super rectam steterit duoque anguli utrobique fuerint æquales: eorum uterque rectus erit. **L**ineaque linee superstitas ei cui superstat perpendicularis vocatur. **A**ngulus quoque qui recto maior est obtusus dicitur. **A**ngulus vero minor recto acutus appellatur. **T**erminus est quod uniuscuiusque lineæ est. **F**igura est quæ termino vel terminis terminatur. **C**irculus est figura plana una quædam linea peripheria nominatur: in cuius medio punctus est: a quo omnes linee recte ad circumferentiâ exeuntes sibi invicem sunt æquales. **E**t hic quidam punctus centrum circuli dicitur. **D**iameter circuli est linea recta que super eius centrum transiens extremitatesque suas circumferentiæ applicans circuli in duo media dividit. **S**emicirculus est figura plana diametro circuli et medietate circumferentiæ peripheria. **P**ortio circuli est figura plana recta linea et parte circumferentiæ peripheria: semicirculo quidem aut maior aut minor. **R**ectilineæ figure sunt quæ rectis lineis continentur: quarum quedam trilateræ quæ tribus rectis lineis: quedam quadrilateræ quæ quatuor rectis lineis: quedam multilateræ que pluribus quæ quatuor rectis lineis continentur. **F**igurarum trilaterarum: alia est triangulus habens tria latera æqualia. Alia triangulus duo habens æqualia latera. Alia triangulus trium inequalium laterum. **I**dem iterum alia est orthogonum: unum scilicet rectum angulum habens. Alia est amblygonum aliquem obtusum angulum habens. Alia est origonum: in qua tres anguli sunt acuti. **F**igurarum autem quadrilaterarum: Alia est quadratum quod est æquilaterum atque rectangulum. Alia est trapezium: quod est figura rectangula: sed æquilatera non est. Alia est rhombus: que est æquilatera: sed rectangula non est.

De principijs per se notis: et primo de definitionibus eorundem.

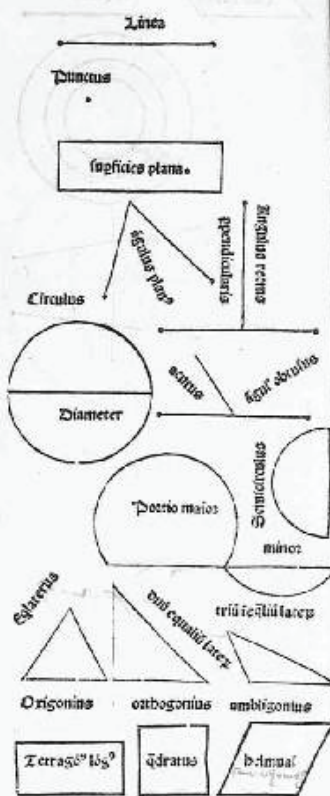

Erhard Ratdolt, Peter Loeslein, and Bernhard Maier, title page for Euclid's *Geometriae Elementa*, 1482. A dazzling white-on-black design brackets the text, and incredibly fine line diagrams in the wide margin visually define Euclid's terms.

in quo quidem nolo ego te il-
irari, quod uulgi solet: magnū
et tantas flammās, tam inmen-
post hominum memoriā sem-
isse, quo alerētur: quid est enim
ui coeli conuexa; qui terras o-
mni si naturam respicimus; nihil
a est, quod mirum uoces: si rem.

Aldus Mautius, from Pietro Bembo's *De Aetna*, 1495–96. As the model for Garamond in the sixteenth century, this typeface became the prototype for two centuries of European typographic design.

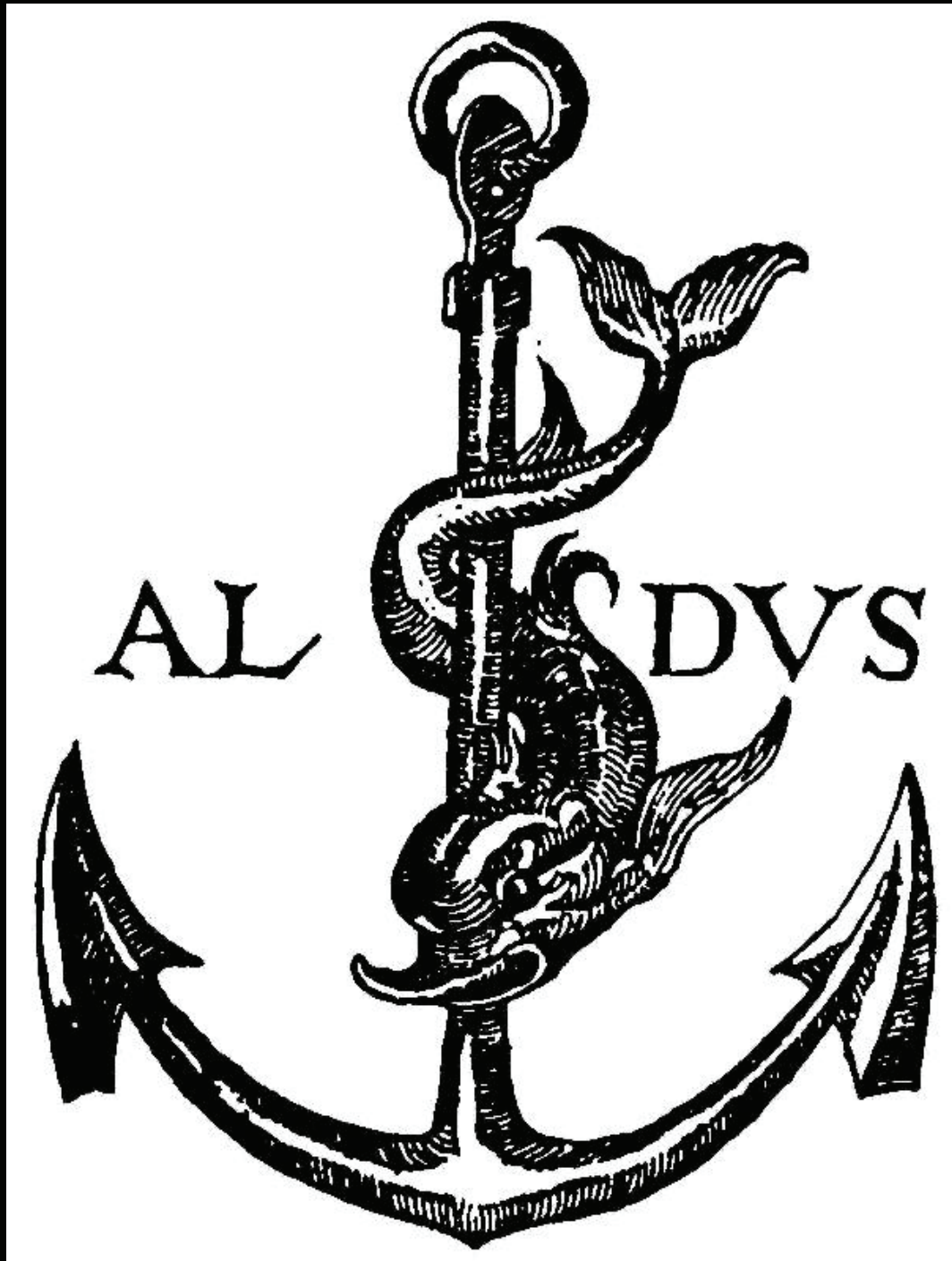

Aldus Manutius, printer's trademark, c. 1500.
The swiftest of sea creatures combines with
an anchor to signify the epigram, "Make
haste slowly."



Initium sancti euangelii secū
dum Ioannem. Gloria tibi domi
ne.



In prin
cipio e
rat verbum et
verbum erat a
pud deum, et
deus erat ver
bum. Hoc erat in principio apud
deum. Omnia per ipsum facta
sunt: et sine ipso factum est ni
hil quod factum est. In ipso vi
ta erat: et vita erat lux hominū
et lux in tenebris lucet, et tene
brae eam non comprehendebat.
Fuit homo missus a deo, cui no
men erat Ioannes. Hic venit in
testimonium vt testimonium
perhiberet de lumine, vt omnes
crederent per illum. Non erat ille
lux, sed vt testimonium perhibe

Geoffroy Tory, pages from the manuscript book *Les heures de Jean Lallemant*, 1506. The armorial frontispiece and forty vignettes have orderly rows of the Latin alphabet's twenty-three letterforms over a blue field with red and white stripes.

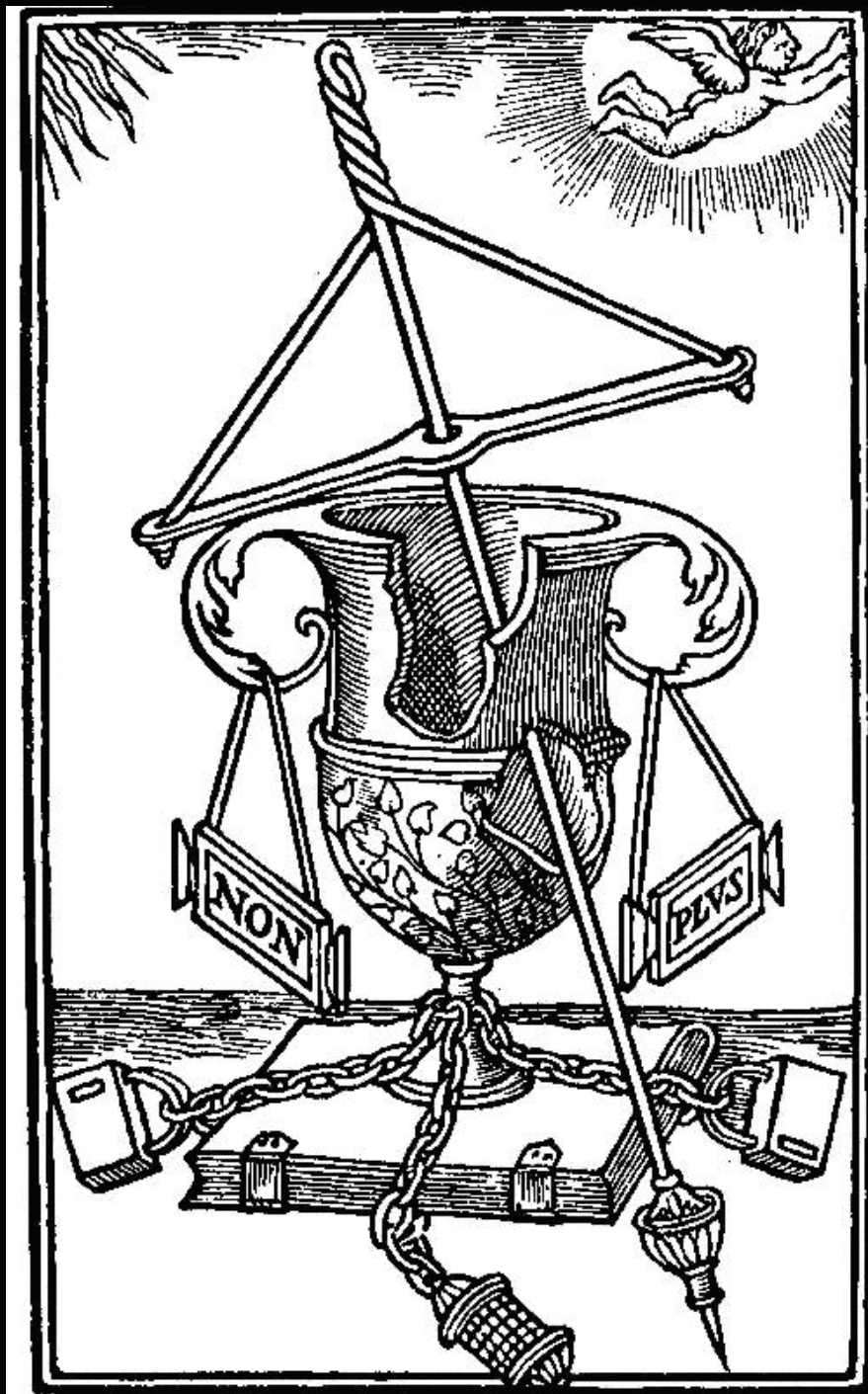

Geoffroy Tory, pot cassé emblem, 1524.
Later, Tory explained that the broken jar symbolized one's body, the toret or auger symbolized fate, and the book held shut by three padlocked chains signified the book of a life after it is shut by death.



Geoffroy Tory, capital from a series of criblé initials, c. 1526. Engraved for Robert Estienne, this alphabet of roman capitals brought elegance and “color” to the pages of books printed at Estienne’s press.



GARAMOND



Corps 48 - N° 3287

A B C D E F G H I

J K L M N O P Q

R S T U V X Y Z

Œ Æ W É È Ê

1 2 3 4 5 6 7 8 9 0 Ç

.,:;' -?! &

a b c d e f g h i j k l m

n o p q r s t u v x y z

é à è ù â ê î ô û ë ï ü

æ œ w ç

99

Caractères de
LA FONDERIE TYPOGRAPHIQUE FRANÇAISE
4, Rue Napoléon-Chaix, PARIS-15^e

Tirage exécuté sur papier des PAPETERIES NAVARRE, 52, avenue de Noailles, à Lyon

Claude Garamond, the great French type-founder of the sixteenth century, immortalized here by the Fonderie Typographique Française around 1920.



Giovanni and Alberto Alvisi, title page from *Ars Moriendi*, 1478. The vocabulary of graphic design possibilities was expanded by the design and casting of metal decorative ornaments that could be composed as part of the page along with type.



Christophe Plantin, title page for *Centvm fabvlae ex antiquis* (*A Hundred Old Stories*), by Gabriello Faerno, 1567. Dignified and architectural, this title page is typical of the Plantin house style.



Trajan's Column

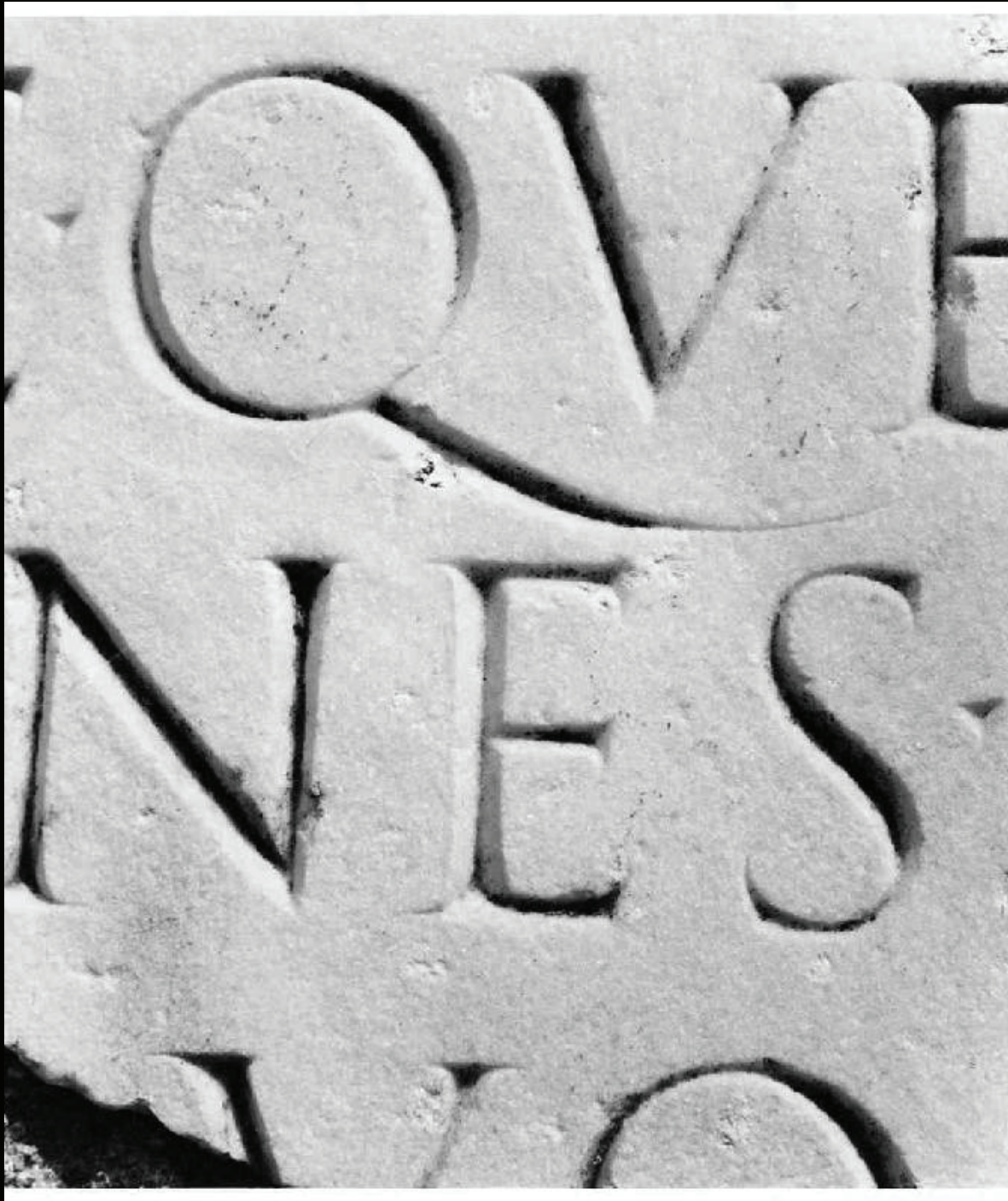

The controlled brush drawing of the forms on the stone combines with the precision of the stonemason's craft to create letterforms of majestic proportion and harmonious form.

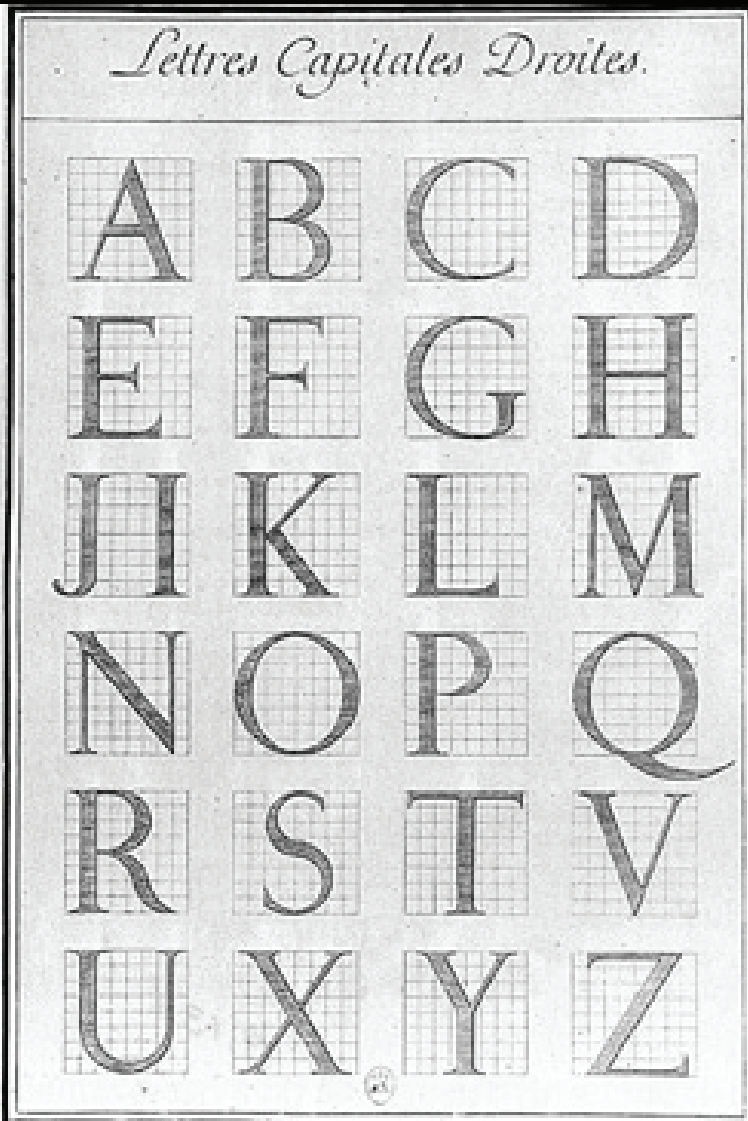
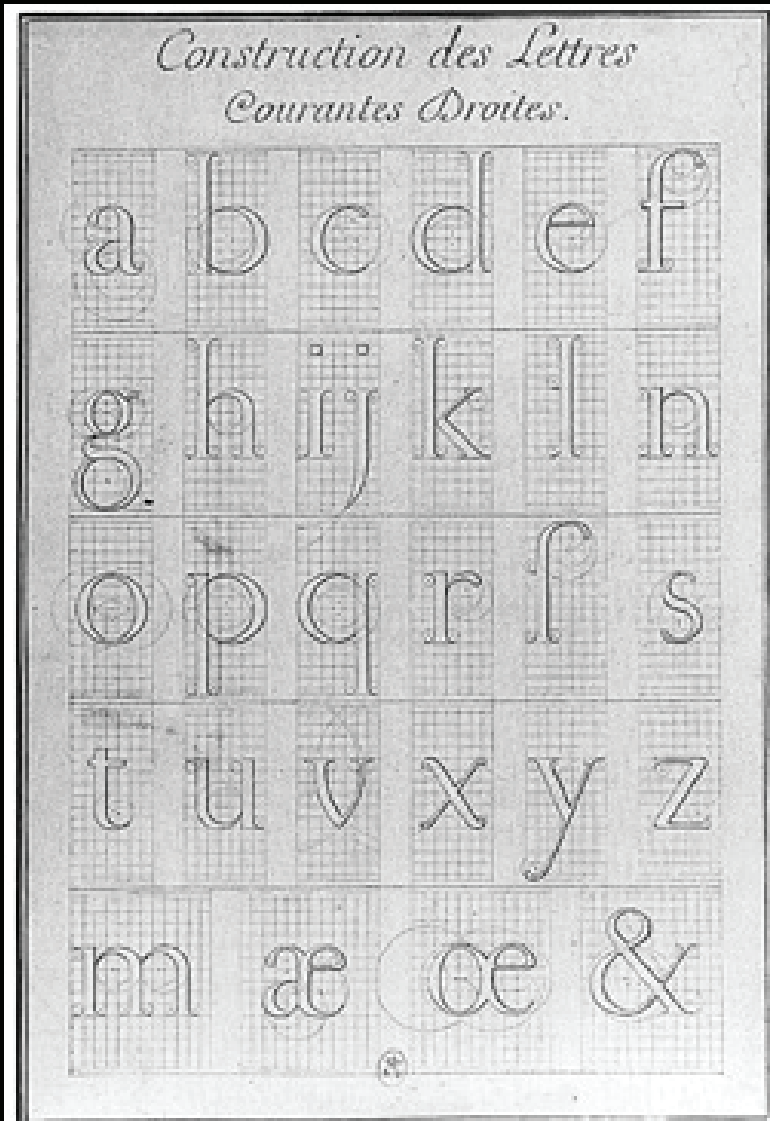

Louis Simonneau, master alphabets for the Romain du Roi, 1695. These copperplate engravings were intended to establish graphic standards for the new alphabet.

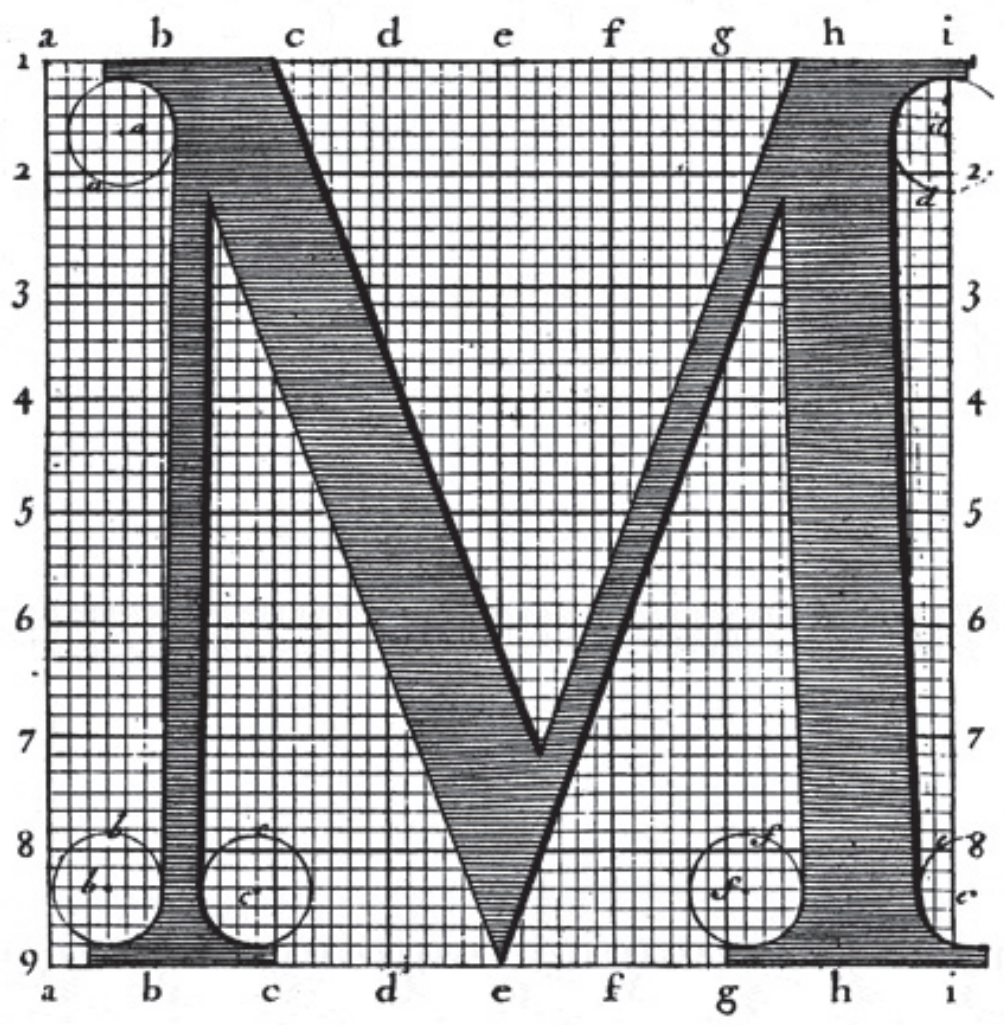

A closer look at the construction of the Romain du Roi.

DE DEUX POINTS. 89

de Philosophie.

A B C D E F G

H I J L M N O

de Cicéro.

A B C D E

de Saint-augustin.

F G H I K

J M L N

Pierre Simon Fournier le Jeune, specimen page of decorative types, 1768. Within each of Fournier's ornamental display letterforms is the structure of a well-proportioned roman letter.

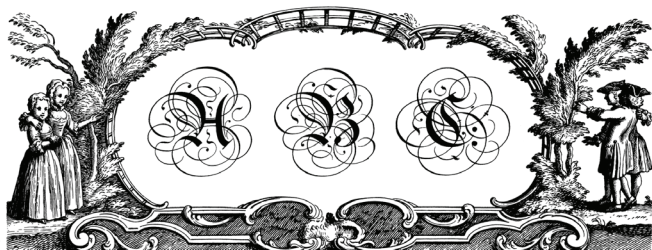

OR,
Alphabets,

In all the usual Hands now Practis'd, &c.

Engrav'd by **G. Bickham, Sen.^r**

*The Alphabet is the whole Order of the Letters in any Language, —
 from Alpha and Beta, the two first Letters in the Greek Tongue. —
 The English Alphabet contains twenty six Letters, but others differ
 in their Number and Form, and vary in their Placing and Writing. —
 The Hebrews write from the Right hand to the Left, Others from
 Left to Right, and back again from Right to Left, The Chinese from
 Top to Bottom, and from Right to Left; but the Europeans, and most
 Others, write from Left to Right, without Retrogression to the Left. —
 All our English Alphabets are exhibited in the two next Pages. —*

*If you would write both Legible and Fair,
 Copy these Alphabets with all your Care.*

George Bickham's Universal Penman.

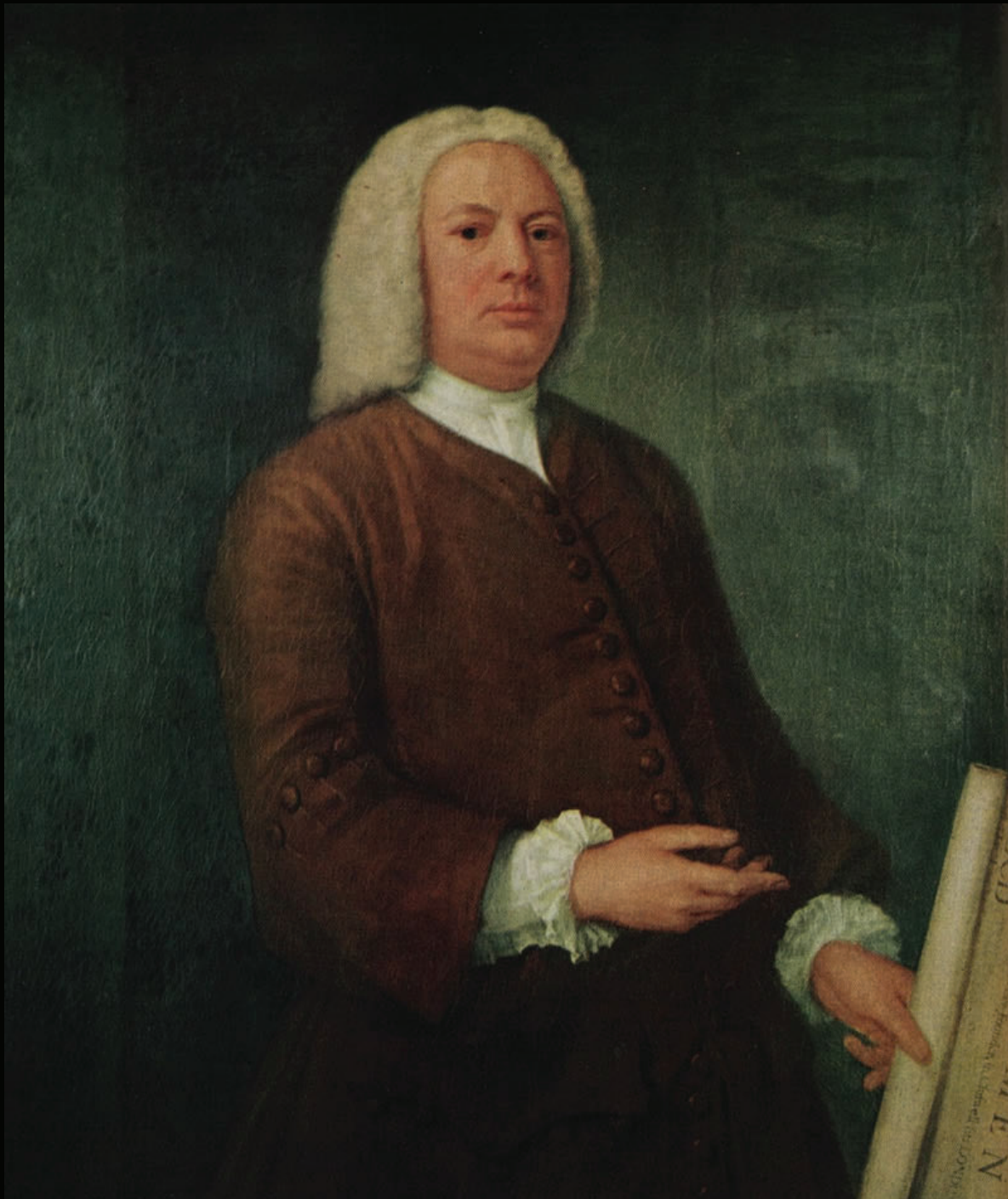

William Caslon

ABCDEFGHIJKLMN
OPQRSTUVWXYZJ

Quousque tandem abutere,
Catilina, patientia nostra? qu
*Quousque tandem abutere, Ca-
tilina, patientia nostra? quam-*

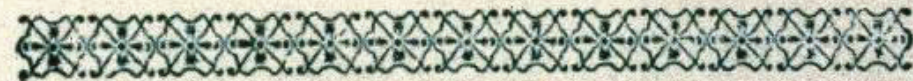

This new Foundery was begun in the Year 1720,
and finish'd 1763; and will (with God's leave) be
carried on, improved, and enlarged, by WILLIAM
CASLON and Son, Letter-Founders in LONDON.



William Caslon, specimens of Caslon roman and italic, 1743. The straightforward practicality of Caslon's designs made them the dominant roman style throughout the British Empire far into the 19th century.



John Baskerville

PUBLII VIRGILII

MARONIS

BUCOLICA,

GEORGICA,

E T

AE NE I S.

BIRMINGHAMIAE:

Typis JOHANNIS BASKERVILLE.

MDCCLVII.

Baskerville, title page for Vergil's *Bucolica, Georgica, et Aeneis* (*Pastorials, Farming, and Aeneis*), 1757. Baskerville reduced the design to letterforms symmetrically arranged and letterspaced.



Giambattista Bodoni, title page from *Saggio tipografico* (*Typographic Essay*), 1771. The tremendous influence of Fournier le Jeune upon Bodoni's earlier work is evident in this page design.

A V I S
AUX SOUSCRIPTEURS
D E
L A G E R U S A L E M M E
L I B E R A T A
IMPRIMÉE PAR DIDOT L'AÎNÉ
SOUS LA PROTECTION ET PAR LES ORDRES
D E M O N S I E U R .

LES ARTISTES choisis par MONSIEUR pour exécuter son édition de LA GERUSALEMME LIBERATA demandent avec confiance aux souscripteurs de cet ouvrage un délai de quelques mois pour en mettre au jour la première livraison. Il est rarement arrivé qu'un ouvrage où sont entrés les ornements de la gravure ait pu être donné au temps préfix pour lequel il avoit été promis : cet art entraîne beaucoup de difficultés qui causent des retards forcés ; et certainement on peut regarder comme un empêchement insurmontable les jours courts et obscurs d'un hiver long et rigoureux. D'ailleurs la quantité d'ouvrages de gravure proposés actuellement par

Designed at the Didot foundry, the typeface used in this announcement for a forthcoming romantic novel is a very early presentation of a true modern-style letterform.

Quousque tandem abutere Catilina, patientia nostra ?
quamdiu nos etiam furor iste tuus eludet ? quem ad
finem sese effrenata jactabit audacia ? nihilne te noc-
turnum præsidium palatii, nihilne urbis vigiliæ, nihil
timor populi, nihil consensus bonorum omnium, nihil
hic munitissimus habendi senatus locus, nihil horum

£1234567890

SALES BY PUBLIC AUCTION.

Robert Besley (designer, with Thorowgood), specimen of an early Clarendon, 1845. Clarendon styles were wildly popular after their introduction. When the 3 year patent expired, numerous imitations were issued by other founders.

A B C D E F G H
I J K L M N O P
R S T U V W X.

Vincent Figgins, five lines pica, In Shade, 1815. The first three-dimensional or perspective fonts were fat faces.

W CASLON JUNR LETTERFOUNDER

William Caslon IV, two-line English Egyptian, 1816. This specimen quietly introduced what was to become a major resource for graphic design.

TWO-LINE GREAT PRIMER SANS-SERIF.

**TO BE SOLD BY AUCTION,
WITHOUT RESERVE;
HOUSEHOLD FURNITURE,
PLATE, GLASS,
AND OTHER EFFECTS.
VINCENT FIGGINS.**

Vincent Figgins, two-line Great Primer Sans-serif, 1832. Both the name and wide use of sans-serif typography were launched by awkward black display fonts in Figgins's 1832 *Specimens of Printing Types*.

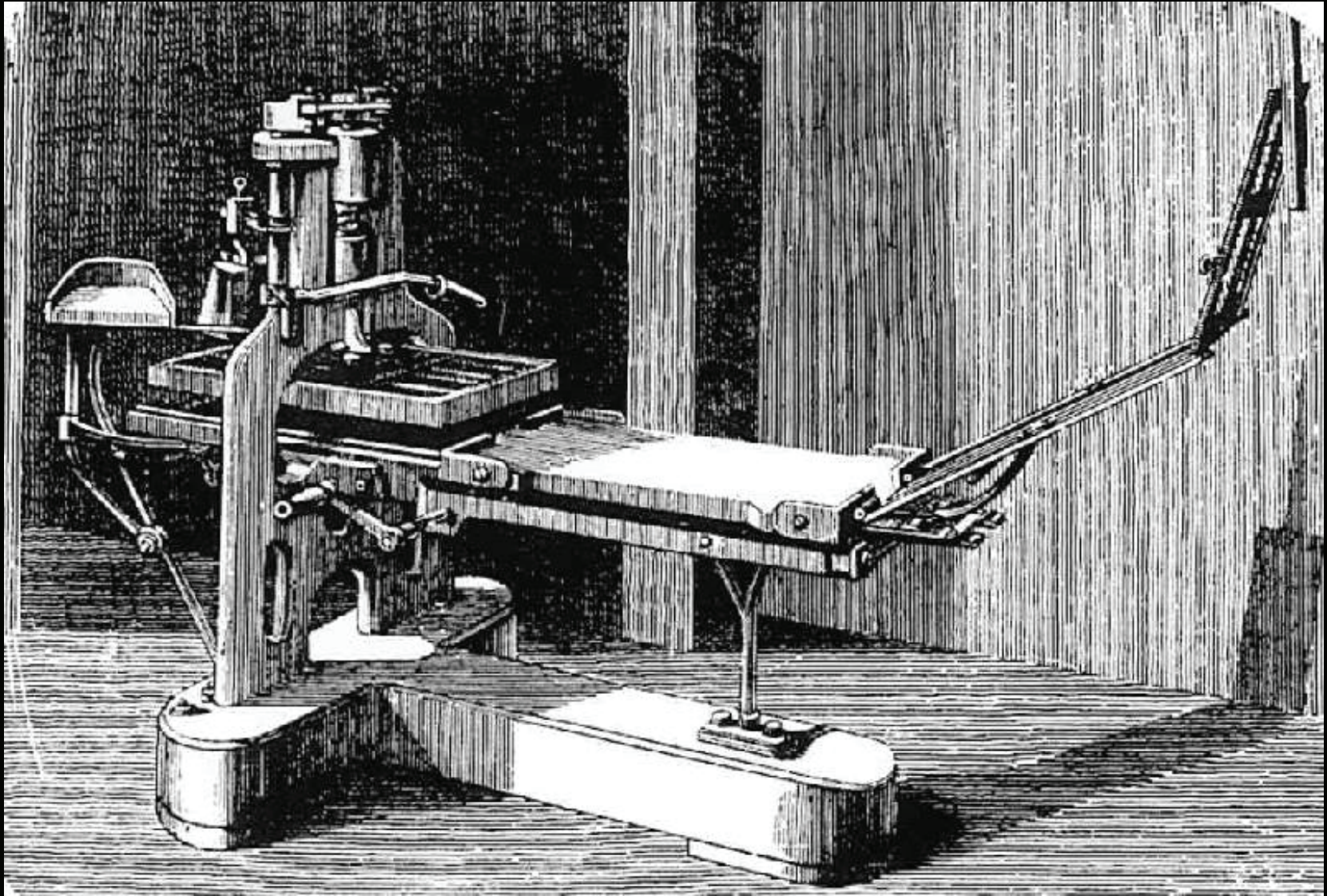

This engraved illustration depicts the printing press of all-iron parts invented in England by Charles, third Earl of Stanhope.

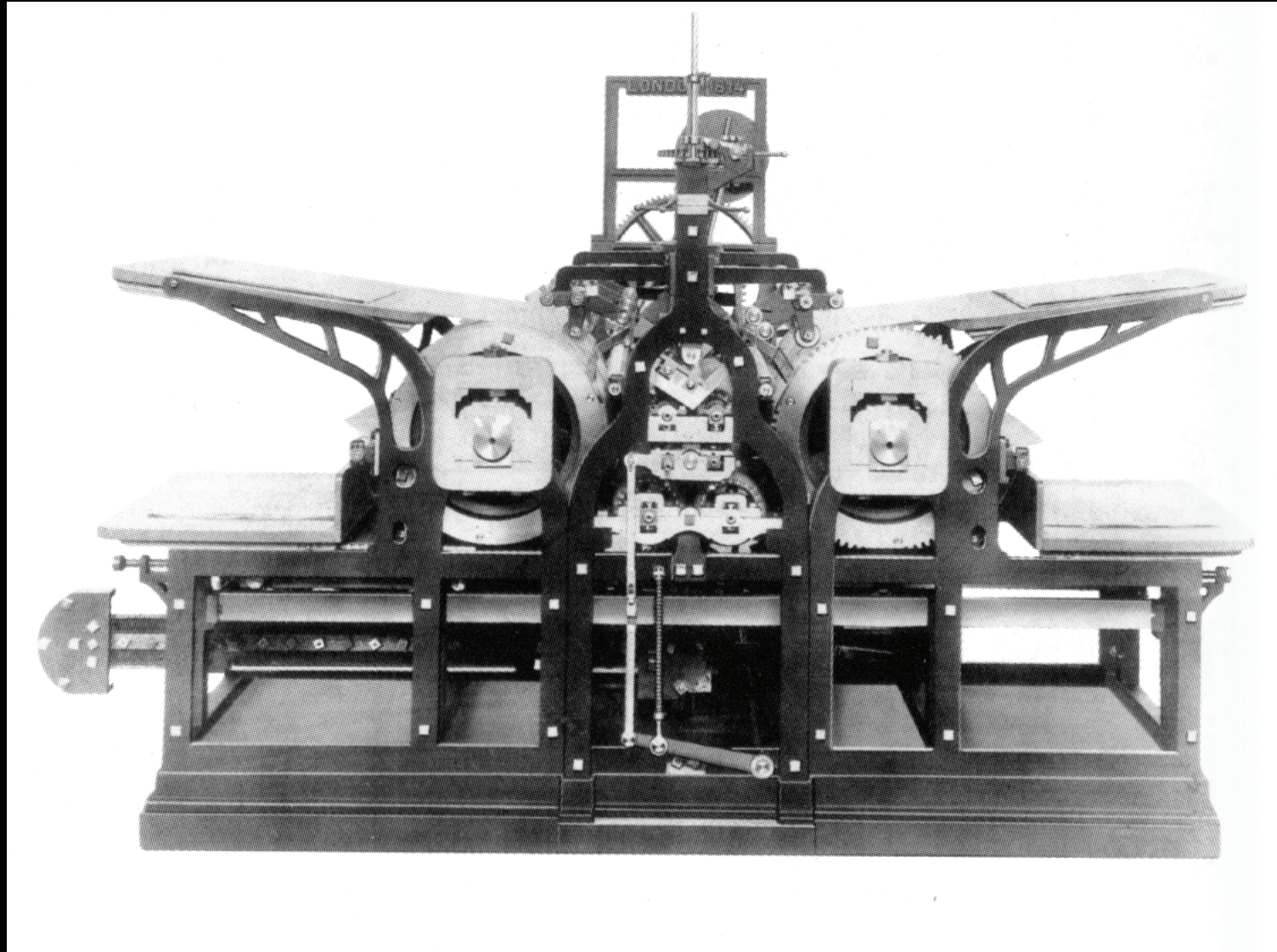

The first steam-powered cylinder press, 1814. Koenig's invention caused the speed of printing to skyrocket, while its price dropped considerably.

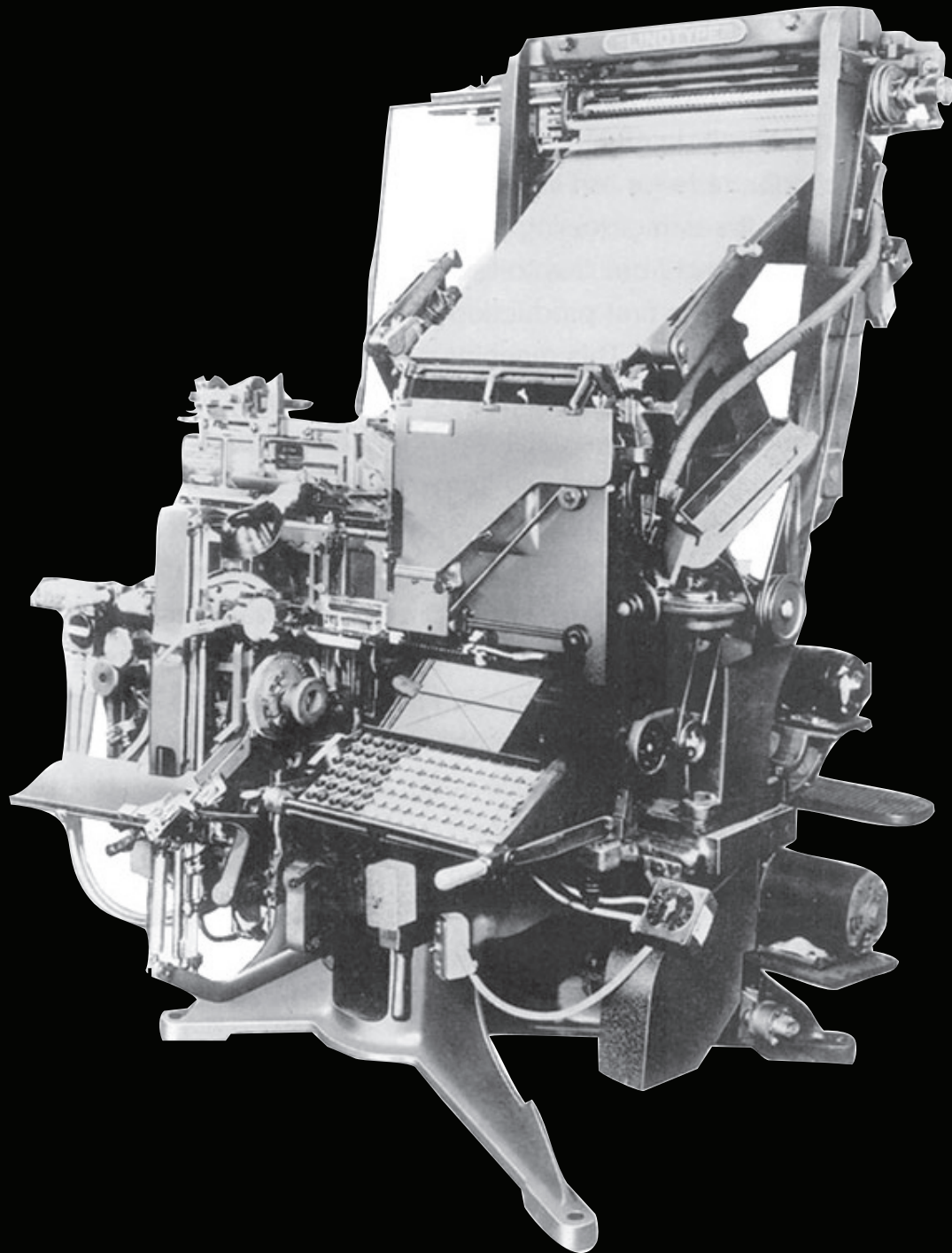

The Model 5 Linotype became the workhorse of typesetting, with keyboards and matrixes available in over a thousand languages.



William Morris

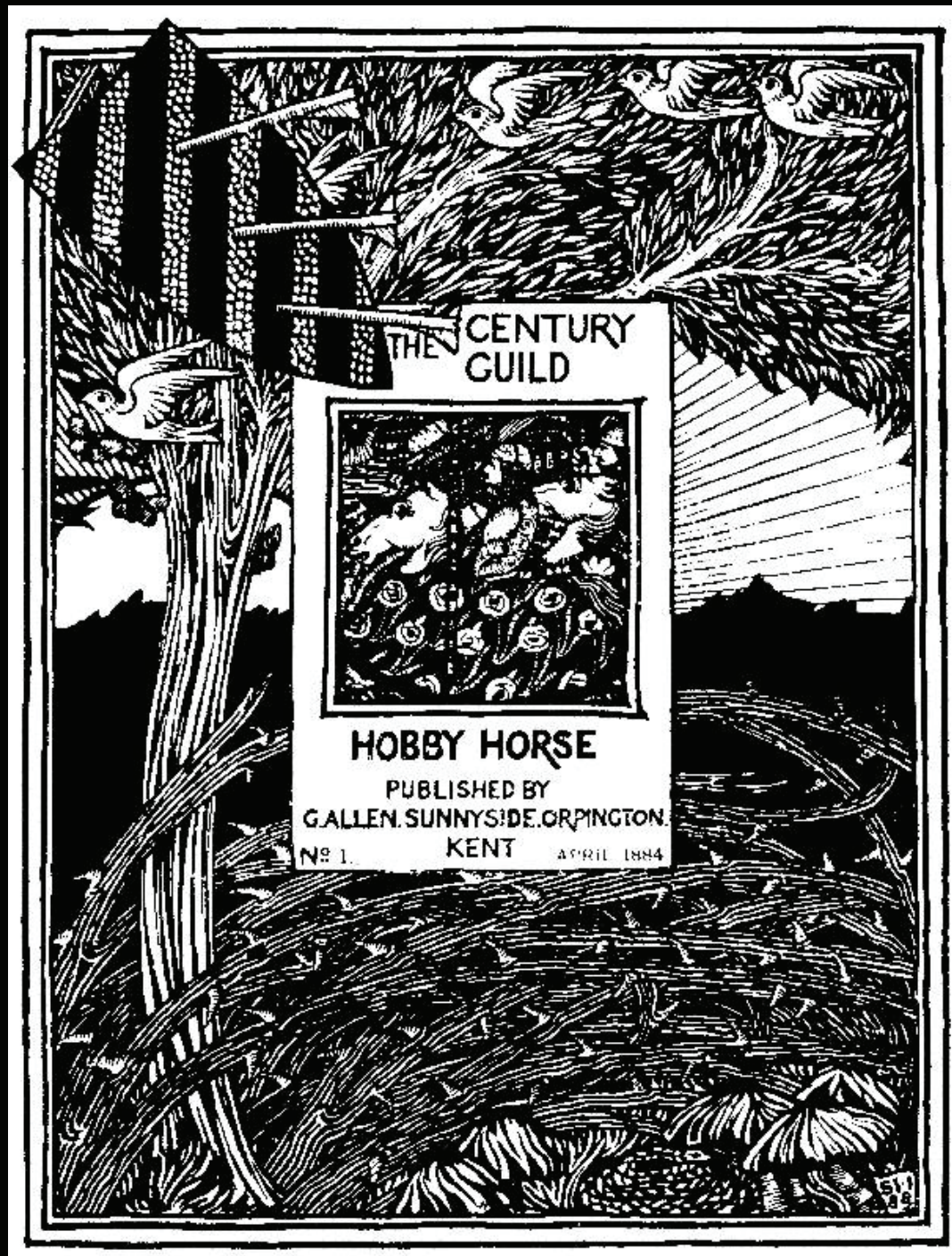

Selwyn Image, title page to *The Century Guild Hobby Horse*, 1884. Packing it with detail, Image designed a “page within a page” that reflects the medieval preoccupation of the Arts and Crafts movement.



Selwyn Image, woodcut from *The Hobby Horse*, 1886. The potential of shape and pattern as visual means to express thought and feeling is realized in this graphic elegy for illustrator/engraver Arthur Burgess.

THE ARTS AND CRAFTS OF
BEING AN ADDRESS DELIVERED
EDINBURGH IN OCTOBER
WILLIAM MORRIS.

‘Applied Art’ is the title which has been chosen for that portion of the arts which we speak to you about. What are we to understand by that title? I should answer that what is meant by applied art is the ornamentation which men choose to add to articles of utility. In a strictly technical sense, of course, theoretically this ornamentation can be done by any man, but if the ornamentation is done by art, the art would then cease to be ‘applied’ and become a kind of abstraction, I suppose. But the ornamentation of articles of utility may be done by any man up to the present time has never been done by art, and perhaps never will; at any rate, I do not propose to do so at present, although

William Morris, Golden typeface, 1888-90. This font inspired renewed interest in Venetian and Old Style typography.

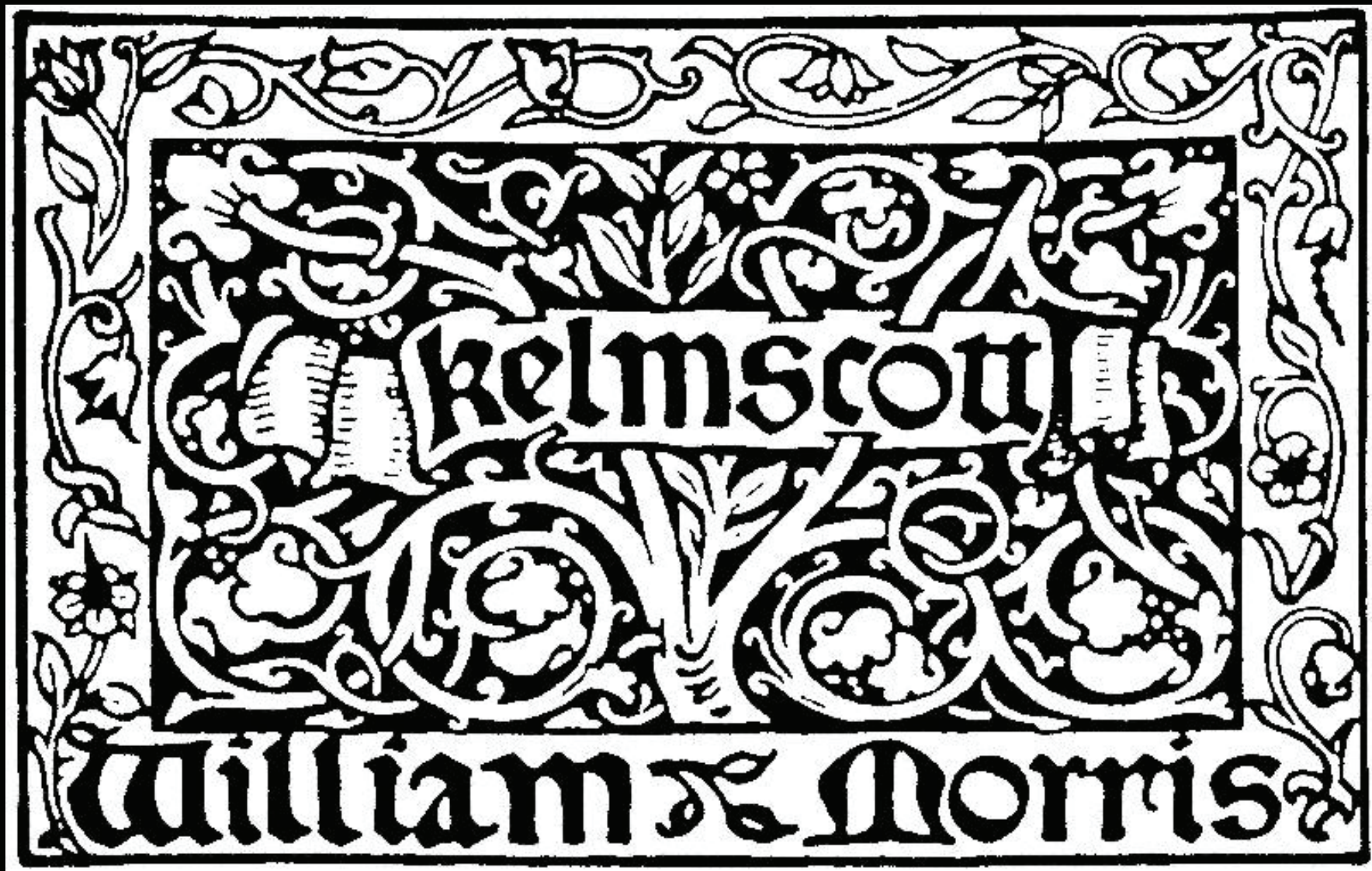

William Morris, trademark for the Kelmscott Press, 1892.

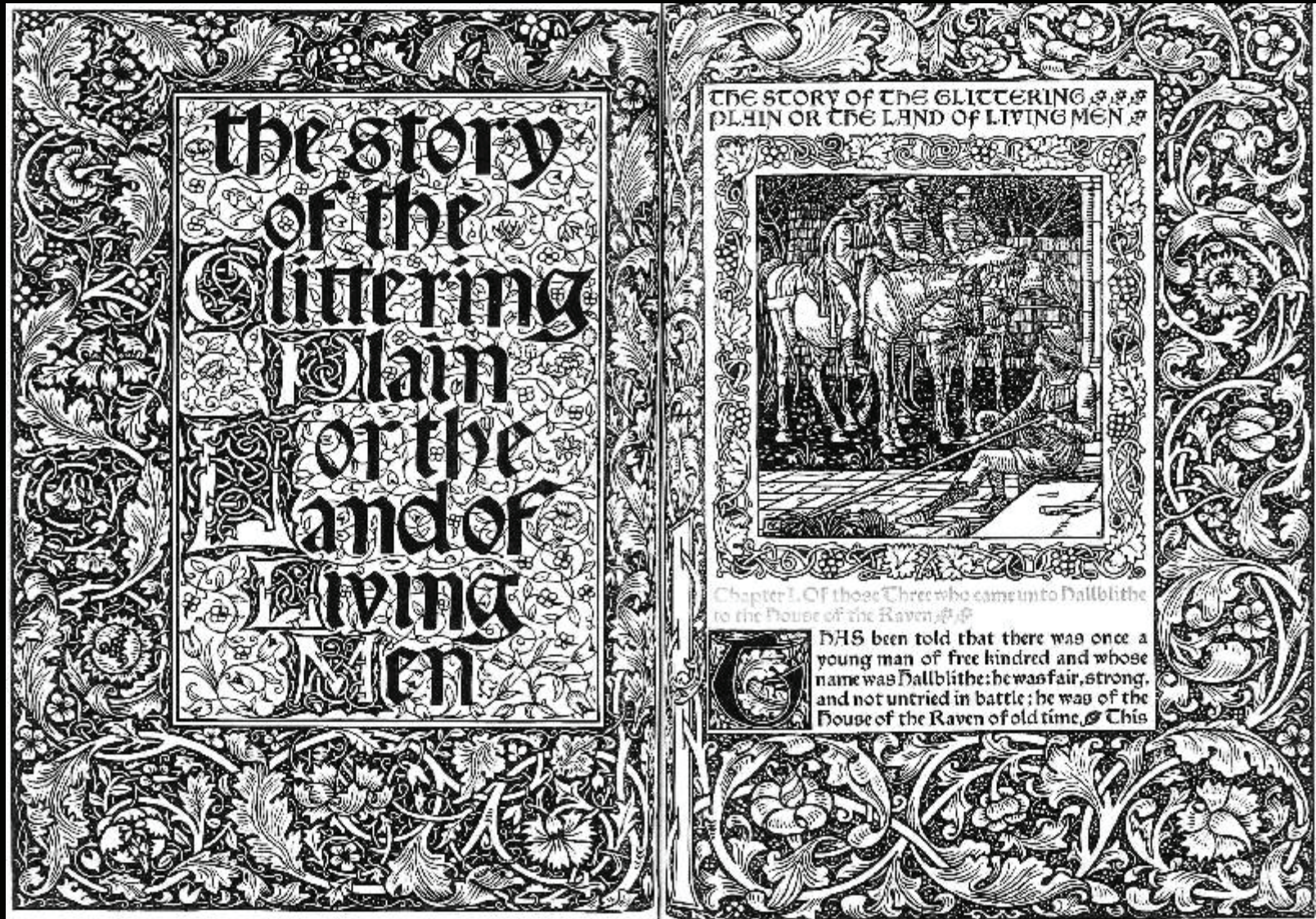

William Morris (designer) and Walter Crane (illustrator), title-page spread for *The Story of the Glittering Plain*, 1894. Operating on his compulsion to ornament the total space, Morris created a luminous range of contrasting values.



Eric Gill

FORASMUCH AS MANY HAVE TAKEN IN HAND TO SET FORTH IN ORDER A DECLARATION OF THOSE THINGS WHICH ARE MOST SURFLY BELIEVED AMONG US, EVEN AS THEY DELIVERED them unto us, which from the beginning were eyewitnesses, and ministers of the word; It seemed good to me also, having had perfect understanding of all things from the very first, to write unto thee in order, most excellent Theophilus, That thou mightest know the certainty of those things, wherein thou hast been instructed.



HERE
WAS
IN THE
DAYS OF
HEROD,

THE KING OF JUDÆA, A CERTAIN PRIEST NAMED ZACHARIAS, OF THE COURSE OF ABIA: AND HIS WIFE WAS OF THE DAUGHTERS OF Aaron, and her name was Elisabeth. And they were both righteous before God, walking in all the commandments and

Eric Gill, page from *The Four Gospels*, 1931. Descending type sizes, all capitals on opening lines, unjustified right margins, and initial capitals integrated with illustrations are forged into a unified whole.

Futura

Aa Qq Rr

Aa Qq Rr

d

Zuführung

a b c d e f g h i j k l m
n o p q r s t u v w x y z
0 1 2 3 4 5 6 7 8 9

Designed in 1927-1930 the extensive range of sizes and weights provided vigorous contrasts for printers and designers who adopted the new typography.



Herbert Bayer, universal alphabet, 1925. This experiment in reducing the alphabet to one set of geometrically constructed characters maximizes differences between letters for greater legibility.

VORZUGS-ANGEBOT

Im VERLAG DES BILDUNGSVERBANDES der Deutschen Buchdrucker,
Berlin SW 61, Dreibundstr. 5, erscheint demnächst:

JAN TSCHICHOLD

Lehrer an der Meisterschule für Deutschlands Buchdrucker in München

DIE NEUE TYPOGRAPHIE

Handbuch für die gesamte Fachwelt
und die drucksachenverbrauchenden Kreise

Das Problem der neuen gestaltenden Typographie hat eine lebhaft
Diskussion bei allen Beteiligten hervorgerufen. Wir glauben dem Bedürf-
nis, die aufgeworfenen Fragen ausführlich behandelt zu sehen, zu ent-
sprechen, wenn wir jetzt ein Handbuch der **NEUEN TYPOGRAPHIE**
herausbringen.

Es kam dem Verfasser, einem ihrer bekanntesten Vertreter, in diesem
Buche zunächst darauf an, den engen Zusammenhang der neuen
Typographie mit dem **Gesamtkomplex heutigen Lebens** aufzuzei-
gen und zu beweisen, daß die neue Typographie ein ebenso notwendi-
ger Ausdruck einer neuen Gesinnung ist wie die neue Baukunst und
alles Neue, das mit unserer Zeit anbricht. Diese geschichtliche Notwen-
digkeit der neuen Typographie belegt weiterhin eine kritische Dar-
stellung der **alten Typographie**. Die Entwicklung der **neuen Male-
rei**, die für alles Neue unserer Zeit geistig bahnbrechend gewesen ist,
wird in einem reich illustrierten Aufsatz des Buches leicht faßlich dar-
gestellt. Ein kurzer Abschnitt „**Zur Geschichte der neuen Typograp-
hie**“ leitet zu dem wichtigsten Teile des Buches, den **Grundbegriffen
der neuen Typographie** über. Diese werden klar herausgeschält,
richtige und falsche Beispiele einander gegenübergestellt. Zwei wei-
tere Artikel behandeln „**Photographie und Typographie**“ und
„**Neue Typographie und Normung**“.

Der Hauptwert des Buches für den Praktiker besteht in dem zweiten
Teil „**Typographische Hauptformen**“ (siehe das nebenstehende
Inhaltsverzeichnis). Es fehlte bisher an einem Werke, das wie dieses Buch
die schon bei einfachen Satzaufgaben auftauchenden gestalterischen
Fragen in gebührender Ausführlichkeit behandelte. Jeder Teilabschnitt
enthält neben **allgemeinen typographischen Regeln** vor allem die
Abbildungen aller in Betracht kommenden **Normblätter** des Deutschen
Normenausschusses, alle ändern (z. B. postalischen) **Vorschriften** und
zahlreiche Beispiele, Gegenbeispiele und Schemen.

Für jeden Buchdrucker, insbesondere jeden Akzidenzsetzer, wird „Die
neue Typographie“ ein **unentbehrliches Handbuch** sein. Von nicht
geringerer Bedeutung ist es für Reklamefachleute, Gebrauchsgraphiker,
Kaufleute, Photographen, Architekten, Ingenieure und Schriftsteller,
also für alle, die mit dem Buchdruck in Berührung kommen.

INHALT DES BUCHES

Werden und Wesen der neuen Typographie

Das neue Weltbild
Die alte Typographie (Rückblick und Kritik)
Die neue Kunst
Zur Geschichte der neuen Typographie
Die Grundbegriffe der neuen Typographie
Photographie und Typographie
Neue Typographie und Normung

Typographische Hauptformen

Das Typosignet
Der Geschäftsbrief
Der Halbbrief
Briefhüllen ohne Fenster
Fensterbriefhüllen
Die Postkarte
Die Postkarte mit Klappe
Die Geschäftskarte
Die Besuchskarte
Werbaachen (Karten, Blätter, Prospekte, Kataloge)
Das Typoplakat
Das Bildplakat
Schildformate, Tafeln und Rahmen
Inserate
Die Zeitschrift
Die Tageszeitung
Die illustrierte Zeitung
Tabellensatz
Das neue Buch

Bibliographie Verzeichnis der Abbildungen Register

Das Buch enthält über **125 Abbildungen**, von
denen etwa ein Viertel **zweifarbige** gedruckt ist,
und umfaßt gegen **200 Seiten** auf gutem Kunst-
druckpapier. Es erscheint im Format **DIN A 5 (148×
210 mm)** und ist biegsam in Ganzleinen gebunden.

Preis bei Vorbestellung bis 1. Juni 1928: **5.00 RM**
durch den Buchhandel nur zum Preise von **6.50 RM**

Bestellschein umstehend ➡

Jan Tschichold, brochure for his book *Die neue Typographie*, 1928. This brochure functions as a remarkable didactic example of the principles Tschichold was advocating.

Bishop accuses the police over Lewisham clashes

The police were criticised yesterday for the way they handled the rioting at Lewisham on Saturday, in which 55 policemen and at least 56 members of the public were injured. A total of 202 people were charged with offences (Report, page 2). The Bishop of Southwark, Dr Stockwood, accused the Home Secretary, Dr Ian Gamm, of Metropolitan Police Commissioner of a grave

error of judgment. The mayor of Lewisham also laid much of the blame for the day's events on the commissioner. The Socialist Workers' Party, which was leading much of the violence, claimed a victory over the National Front and promised to turn out in even greater strength at the next Front march, planned for Streatham on September 24.

Grave error of judgment, Dr Stockwood says

By Robert Parker and Ian Bradley
The police handling of the Lewisham riot on Saturday was criticised by church leaders yesterday while the Socialist Workers' Party, a key element in the day's violence, promised the National Front demonstrations. The Bishop of Southwark, Dr Stockwood, who led a multinational anti-racism vigil in Lewisham during the riot, said the police had "made a grave error of judgment" in the way they handled the riot. He said the police had "made a grave error of judgment" in the way they handled the riot. He said the police had "made a grave error of judgment" in the way they handled the riot.

Dr Stockwood said the police had "made a grave error of judgment" in the way they handled the riot. He said the police had "made a grave error of judgment" in the way they handled the riot. He said the police had "made a grave error of judgment" in the way they handled the riot. He said the police had "made a grave error of judgment" in the way they handled the riot.

'They went mad... they shot or stabbed anyone' Thai village chief tells of atrocities on border by Khmer Rouge troops

From Peter MacBarnett
A Thai village chief has told of atrocities committed by Khmer Rouge troops on the border between Thailand and Cambodia. He said the troops "went mad" and "shot or stabbed anyone" they met. He said the troops had "killed many people" and "burned many villages". He said the troops had "taken many people captive" and "forced them to work in the fields". He said the troops had "taken many people captive" and "forced them to work in the fields". He said the troops had "taken many people captive" and "forced them to work in the fields".

Mr Karpov stoops to check his juniors

By Robin Viner
A Russian victory to London was attacked in a scathing article by a British chess expert. He said the victory was "a fluke" and that the Russian player, Anatoly Karpov, was "not a world-class player". He said Karpov's victory was "a fluke" and that the Russian player, Anatoly Karpov, was "not a world-class player". He said Karpov's victory was "a fluke" and that the Russian player, Anatoly Karpov, was "not a world-class player".

He added that with the British, although a member of Lewisham will appear in more than one court as the result of the riot. He said the police had "made a grave error of judgment" in the way they handled the riot. He said the police had "made a grave error of judgment" in the way they handled the riot. He said the police had "made a grave error of judgment" in the way they handled the riot.

He said the police had "made a grave error of judgment" in the way they handled the riot. He said the police had "made a grave error of judgment" in the way they handled the riot. He said the police had "made a grave error of judgment" in the way they handled the riot. He said the police had "made a grave error of judgment" in the way they handled the riot.

Israel alters policy in occupied territories

From Our Correspondent
Tel Aviv, Aug 14
The Israeli Cabinet today altered its policy in the occupied territories. It decided to "freeze" the number of Jewish settlers in the West Bank and Gaza. It also decided to "freeze" the number of Jewish settlers in the West Bank and Gaza. It also decided to "freeze" the number of Jewish settlers in the West Bank and Gaza.

Anglo-US peace plan for Rhodesia agreed

From Our Correspondent
Washington, Aug 14
The United States and Great Britain have agreed a peace plan for Rhodesia. The plan calls for a "cease-fire" and a "negotiated settlement". It also calls for a "cease-fire" and a "negotiated settlement". It also calls for a "cease-fire" and a "negotiated settlement".

He said the police had "made a grave error of judgment" in the way they handled the riot. He said the police had "made a grave error of judgment" in the way they handled the riot. He said the police had "made a grave error of judgment" in the way they handled the riot. He said the police had "made a grave error of judgment" in the way they handled the riot.

He said the police had "made a grave error of judgment" in the way they handled the riot. He said the police had "made a grave error of judgment" in the way they handled the riot. He said the police had "made a grave error of judgment" in the way they handled the riot. He said the police had "made a grave error of judgment" in the way they handled the riot.

He said the police had "made a grave error of judgment" in the way they handled the riot. He said the police had "made a grave error of judgment" in the way they handled the riot. He said the police had "made a grave error of judgment" in the way they handled the riot. He said the police had "made a grave error of judgment" in the way they handled the riot.

He said the police had "made a grave error of judgment" in the way they handled the riot. He said the police had "made a grave error of judgment" in the way they handled the riot. He said the police had "made a grave error of judgment" in the way they handled the riot. He said the police had "made a grave error of judgment" in the way they handled the riot.

Liberals call for ban on Front marches

By Paul Reynolds
The Government and Opposition have agreed to support a bill to ban Front marches. The bill would make it an offence to hold a march or procession in support of a political party or organisation. It would also make it an offence to hold a march or procession in support of a political party or organisation.

He said the police had "made a grave error of judgment" in the way they handled the riot. He said the police had "made a grave error of judgment" in the way they handled the riot. He said the police had "made a grave error of judgment" in the way they handled the riot. He said the police had "made a grave error of judgment" in the way they handled the riot.

He said the police had "made a grave error of judgment" in the way they handled the riot. He said the police had "made a grave error of judgment" in the way they handled the riot. He said the police had "made a grave error of judgment" in the way they handled the riot. He said the police had "made a grave error of judgment" in the way they handled the riot.

He said the police had "made a grave error of judgment" in the way they handled the riot. He said the police had "made a grave error of judgment" in the way they handled the riot. He said the police had "made a grave error of judgment" in the way they handled the riot. He said the police had "made a grave error of judgment" in the way they handled the riot.

Figures show size of Army role in Ulster

The eight anniversary of the British Army's involvement in security operations in Northern Ireland is marked today. Figures show the size of the Army's role in Ulster. The Army has been involved in security operations in Northern Ireland since 1969. It has been involved in security operations in Northern Ireland since 1969. It has been involved in security operations in Northern Ireland since 1969.

More Spanish hotels hit by strikes

More Spanish hotels are being hit by strikes. The strikes are being led by the Hotel Workers' Union. The strikes are being led by the Hotel Workers' Union. The strikes are being led by the Hotel Workers' Union. The strikes are being led by the Hotel Workers' Union.

Leyland imports help to preserve jobs

Leyland imports are helping to preserve jobs. The Leyland Group has announced that it will continue to import Leyland vehicles. The Leyland Group has announced that it will continue to import Leyland vehicles. The Leyland Group has announced that it will continue to import Leyland vehicles.

The Minstrel for stud in UK

The Minstrel, winner of the English and Irish titles, will be sent to the UK. The Minstrel, winner of the English and Irish titles, will be sent to the UK. The Minstrel, winner of the English and Irish titles, will be sent to the UK.

Boeing offer to UK

Boeing has offered to sell the Boeing 737 to the UK. Boeing has offered to sell the Boeing 737 to the UK. Boeing has offered to sell the Boeing 737 to the UK. Boeing has offered to sell the Boeing 737 to the UK.

Hunt's engine fails

Hunt's engine has failed. The engine failed during a test run. The engine failed during a test run. The engine failed during a test run. The engine failed during a test run.

£100 heating bills

£100 heating bills are being paid. The bills are being paid by the Government. The bills are being paid by the Government. The bills are being paid by the Government.

Cyprus succession

Cyprus succession is being discussed. The Government is discussing the succession of Cyprus. The Government is discussing the succession of Cyprus. The Government is discussing the succession of Cyprus.

Three die in M6 multiple crash

Three people died in a multiple crash on the M6. The crash occurred on the M6. The crash occurred on the M6. The crash occurred on the M6.

An appeal from the heart

An appeal from the heart. The British Heart Foundation is appealing for donations. The British Heart Foundation is appealing for donations. The British Heart Foundation is appealing for donations.

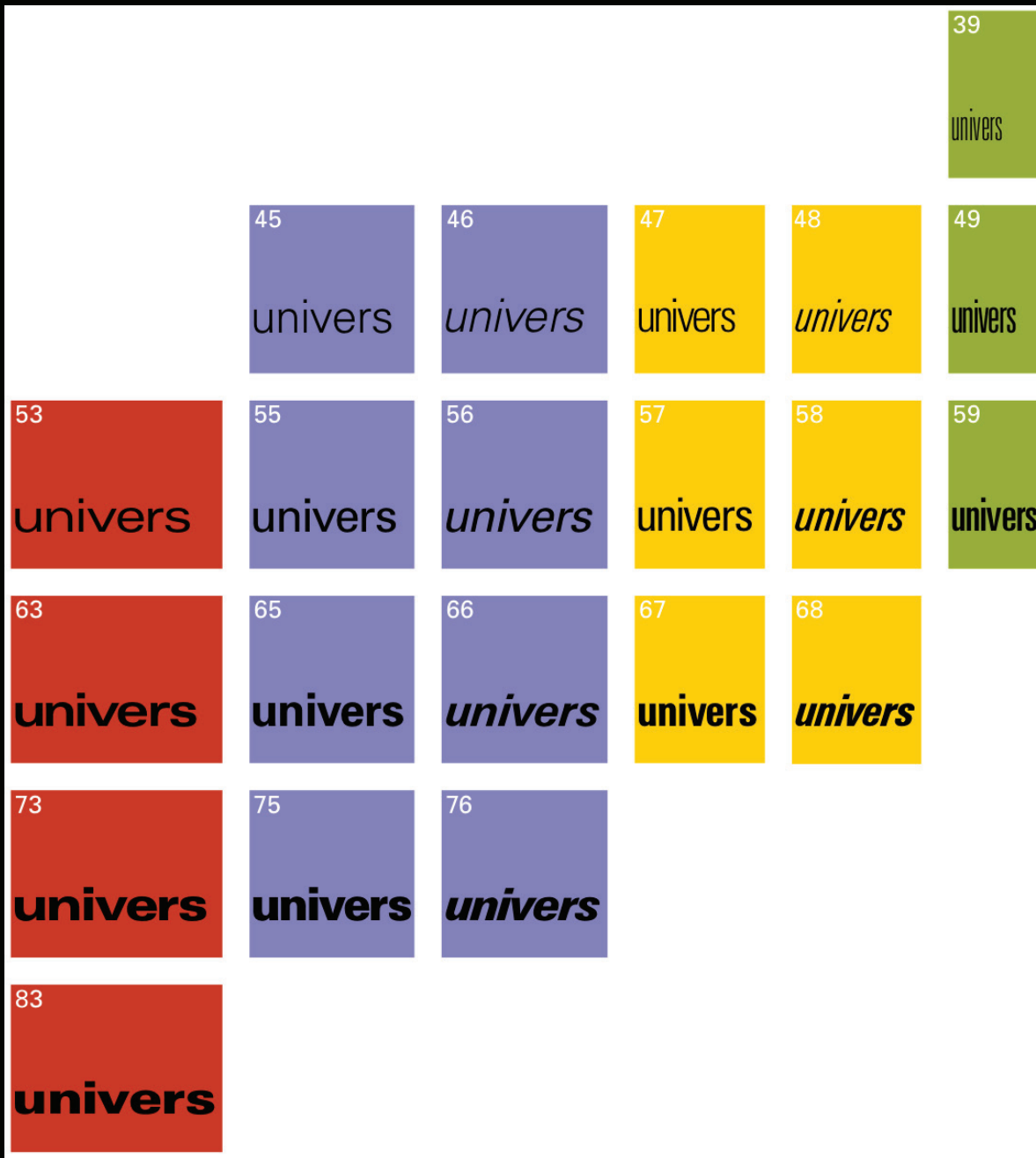

Adrian Frutiger, schematic diagram of the twenty-one Univers fonts, 1954. Frutiger systematically altered the forms of fonts located on the chart above, below, and to the left and right of Univers 55.



Composition with the letter u. All twenty-one variations of Univers can be used together to achieve dynamic contrasts of weight, tone, width, and direction.

A Brief History of Helvetica

Helvetica was developed in 1957 by Max Miedinger with Eduard Hoffmann at the Haas'sche Schriftgiesserei (Haas type foundry) of Münchenstein, Switzerland. Haas set out to design a new sans-serif typeface that could compete with Akzidenz-Grotesk in the Swiss market. Originally called **Die Neue Haas Grotesk**, it was created based on **Schelter-Grotesk**. The aim of the new design was to create a neutral typeface that had great clarity, had no intrinsic meaning in its form, and could be used on a wide variety of signage.

A B C D E
F G H I J K
L M N O P
Q R S T U
V W X Y Z

The quick brown fox jumps over the lazy dog.

The quick brown fox jumps over the lazy dog.

The quick brown fox jumps over the lazy dog.

The quick brown fox jumps over the lazy dog.

Edouard Hoffman and Max Miedinger, Helvetica typeface, 1961. The basic version of Helvetica was released by the Stempel foundry in 1961.



Frederic W. Goudy

THE
CAXTON
BOOK

A FEW RECORDS OF THE PAST·BE-
ING PROPHECIC OF THE FUTURE

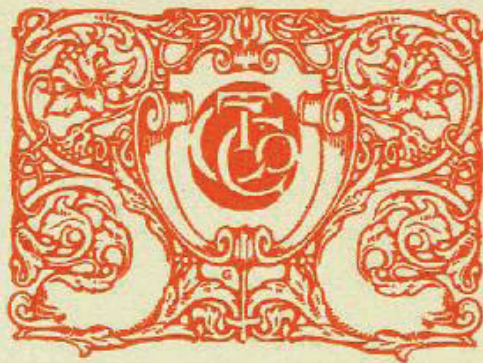

CLEVELAND
THE CAXTON CO.
MCMXI

Frederic W. Goudy, booklet cover, 1911. The ideals of the Arts and Crafts movement were actualized in printing for commerce.

The GOUDY TYPE
FAMILY *at a Glance*

*A Composite Picture of the complete GOUDY TYPE
FAMILY is here shown for the first time*

Goudy Catalogue

Goudy Catalogue Italic

Goudy Oldstyle

Goudy Italic

Goudy Cursive

GOUDY TITLE

Goudy Bold

Goudy Bold Italic

Goudy Handtooled

Goudy Handtooled Italic

AMERICAN TYPE FOUNDERS COMPANY

Page 45 from American Type Founders' Specimen Book and Catalogue 1923 presented the Goudy series of Old Style fonts, including fonts designed by others.

THE CENTAUR. WRITTEN BY MAURICE DE GUÉRIN AND NOW TRANSLATED FROM FRENCH BY GEORGE B. IVES.



Was born in a cavern of these
Like the river in yonder valley
drops flow from some cliff that
deep grotto, the first moment
sped amidst the shadows of a
treat, nor vexed its silence. As
draw near their term, they retire
erns, and in the innermost recesses
wildest of them all, where the
most dense, they bring forth, uncomplaining, offspring
themselves. Their strength-giving milk enables us to
out weakness or dubious struggles the first difficulties

Bruce Rogers, page from *The Centaur*, by Maurice de Guerin, 1915. The headpiece, initial, and page layout echo the wonderful graphic designs of the French Renaissance.



Photolettering film

HELL

WELCOME TO PHOTO-LETTERING.COM

START

LOG

LEARN MORE

CREATE ACCO

Photolettering today.



Herb Lubalin



MARRIAGE

Herb Lubalin, typogram from a Stettler typeface announcement poster, 1965. Marriage, “the most licentious of human institutions,” becomes an illustration through the joined Rs.

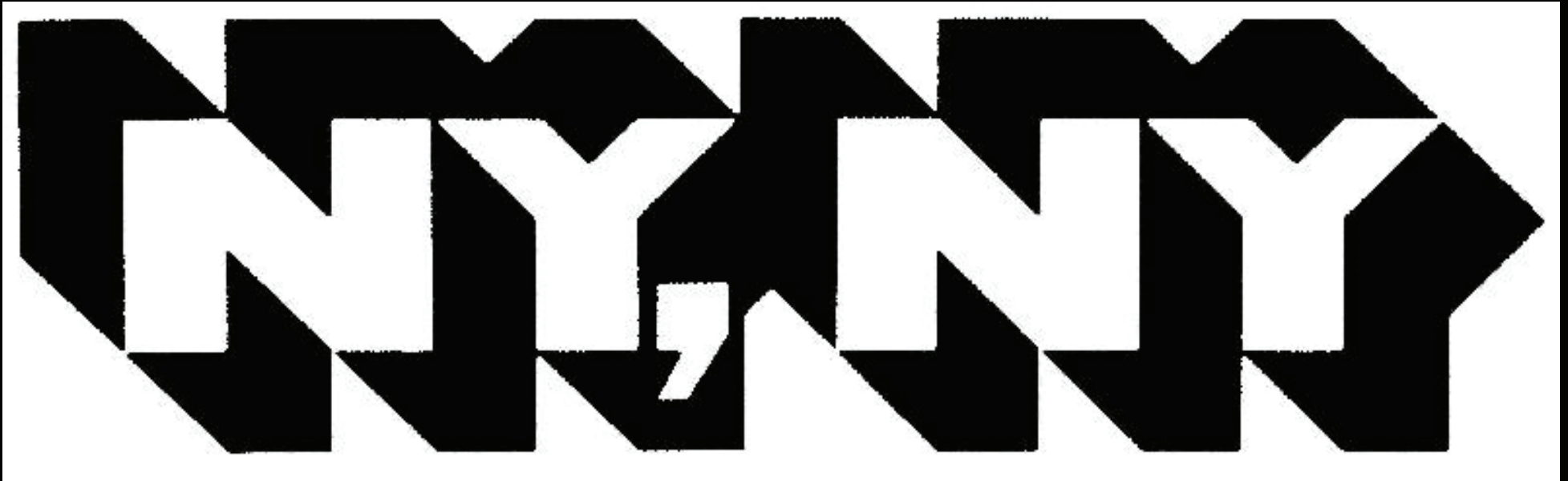

Herb Lubalin, proposed New York City logo, 1966. Isometric perspective creates a dynamic tension between two- and three-dimensionality while implying the city's high-rise architecture.

U&C.

Aa Bb Cc Dd Ee Ff Gg Hh Ii Jj Kk Ll Mm Nn Oo Pp

Qq Rr Ss Tt Uu Vv Ww Xx Yy Zz 1234567890&@#%*~!@ []

UPPER AND LOWER CASE, THE INTERNATIONAL JOURNAL OF TYPOGRAPHY

PUBLISHED BY THE INTERNATIONAL TYPEFACE CORPORATION, VOLUME ONE, NUMBER ONE, 1973

In this issue:

Typography and the New Technologies

A retrospective by Aaron Burns of the development of the emerging technologies in the 20th Century; the challenges, the opportunities.

Information, Please

The New York Times Information Bank is a computerized system that can help you find out everything about anybody or anything—that was reported in a newspaper or magazine.

Stop the "Perpetrators"

A scathing indictment by Edward Rondthaler of the unscrupulous typeface design pirate companies which unconscionably copy for cut-rate sale the original work of creative artists.

What's so Hot about Robert Indiana?

New York Times Art Critic John Canaday with some biting observations on the work of this painter, with a comparison by a graphic designer of how "love" really should be.

Art and Typography

Willem Sandberg, former Director of Amsterdam's Stedelijk Museum, considers the function of the artist in society and in the shaping of new communications patterns.

Is Avant Garde avant garde?

Presenting the story behind this ITC typeface, how it came to be designed by Herb Lubalin, and why he thinks maybe it should never have happened.

My Best with Letters

Four famous designers offer their one "best" piece of typographic art.

Young Typography

Featuring each issue the best, the most unusual, the most significant work being done by students throughout the world.

The Spencerian Revival

Tom Carnase, one of the foremost designers of letterforms, has created a trend back to Spencerian through his artful handling of this script form.

Corporate Design is Big Business

And small business. Both are finding that the image they present to the public is becoming more and more a factor in their successful growth. The first article on corporate design is by Lou Dorfman, Design Director, Columbia Broadcasting System. The second by Ernie Smith, Proprietor of Port Jerry, a rustic resort.

A Satire of Newspaper Logos

The prominent illustrator and satirist, Chas. Slackman, depicts his graphic impressions of the nature of some of our most prominent newspapers through the redesigns of their logotypes.

Non-Communication

Ed Sorel, one of America's foremost satirists, expresses his views on the subject of non-communication in no uncertain terms. These fascinating drawings will be a regular feature in "U&C."

What's New from ITC

A first-time showing of the newest creations of typeface designers to be offered by ITC to the world buying public through ITC Subscribers.



PAGE 4



PAGE 5



PAGE 9



PAGE 11



PAGE 12



PAGE 14



PAGE 20

Typography and the New Technologies

When I went to an school, I learned that many of my fellow students had problems when it came to drawing certain parts of the human anatomy. They simply could not draw hands or feet.

I first became conscious of their difficulties when I noticed that the people who appeared in their layouts never had hands or feet. Hands always seemed to be behind peoples' backs or in pockets. Feet were always out of view, either behind a desk, or the people were cropped at the waist or knees.

People, however, do have hands and feet, and very often they must be shown. The advertisements created by these students very often suffered as a result of these simple but important handicaps.

CONTINUED ON PAGE 3

Stop the "Perpetrators"

This article has been labeled "Stop the Perpetrators" for good reason. The storm is genuine.

No adequate law protects the type designer or photocomposing machine manufacturer from unauthorized duplication of the machine's most vital part, the typeframe or font negative. Unauthorized contact duplication of these critical negatives has reached dangerous proportions, and the graphics industry can no longer afford to ignore this. Having an creative talent, it is a bright on the industry's legitimate business practices, and bringing it under control is a worthy endeavor calling for the concerted effort of all. But more about that later, here is the background.

We operate in a free system where ethics and law contribute mightily to the function.

CONTINUED ON PAGE 5

art and typography

Let us consider first the function of the artist in society. The men who handle the antique furniture in my museum have developed a vocabulary of their own when they speak of styles.

They call Louis XIV. Louis with the twisted legs
Louis XV. Louis with the bow legs
Louis XVI. Louis with the straight legs
now the legs of these kings, I guess, actually did not differ so much from each other, but it was not the kings who created these styles. It was the artists, the architects, the painters and sculptors, the musicians and the authors who tried to render the essence of the epoch, who made the impact of a certain period visible, audible, perceptible. The artist creates the face of society, his work enables us to revive the past. To cite an example, the paintings and posters of Toulouse-Lautrec are for us the incarnation of Paris around 1900. How does this come into being?

CONTINUED ON PAGE 14

Information, Please

Suppose that you wanted to find out... WHO is the new head of the Johnson Foundation?

WHAT were the basic terms of the General Motors-Curtis-Wright agreement for the "Market engine"?

WHERE was the Archibiko armistice conducted? WHERE will Swindell-Cresider Company build a steel foundry in Russia?

WHY did Secretary Widge sign a transportation research agreement with the Polish Government?

HOW did Martha Mitchell come to blow the whistle on the Watergate?

Answer: You'd merely consult the remarkable new Information Bank of The New York Times. This eminent newspaper has recently taken a giant step into the 21st Century with the introduction of the world's first computerized system for the storage and retrieval of the richly varied contents of newspapers and magazines.

CONTINUED ON PAGE 11

What's so Hot about Robert Indiana?

A lot of friends in advertising—talented designers all—have been talking to themselves lately. "What," they want to know, "is so hot about Robert Indiana?" "What's his got that we haven't?" they want to know. "Look," they say, "we turn out designs like his—only better—every day in the week." "What's so special about Robert Indiana?"

What indeed? I was mulling this over the other day when I came across an article by New York Times Art Critic John Canaday. Mr. Canaday was exploring this very idea. He'd just been to a recent new exhibition at the Denise Rene Gallery in New York, which was presenting a one-man show of Indiana's designs, and he hadn't gotten over it yet.

For the uninitiated, Robert Indiana is the creator of LOVE, that cleverly-arranged four

CONTINUED ON PAGE 7

Herb Lubalin, cover for U&C. 59 typographic elements, 7 illustrations, and 12 rules—a total of 78 separate elements—are integrated into an information-filled page.





The first mouse, a small wooden box on steel wheels, was invented by scientist Douglas C. Engelbart in the 1960s at the federal government's Augmentation Research Center



The Macintosh, 1984.



Zuzana Licko & Rudy Vanderlans



April Greiman, poster for the Los Angeles Institute of Contemporary Art, 1986. Computer output, printed as layers of lavender, blue-gray, red-orange, and tan, overlap and combine into an even fuller palette of color.

11

EMIGRE

PRICE \$7.95

Graphic Designers and the **MACINTOSH** Computer

Philippe Apeloig **PARIS** / John Weber
COLUMBUS / Henk Elenga [Hard Werken] **LOS**
ANGELES / Takenobu Igarashi **TOKYO** / Gerard
Kadders & Rick Vermeulen [Hard Werken]
ROTTERDAM / Rick Valicenti [Thirst] **CHICAGO** /
Max Kisman **AMSTERDAM** / Clement Mok **SAN**
FRANCISCO / Eric Spiekermann **BERLIN** / Jeffery
Keedy **LOS ANGELES** / Glenn Suokko **MILNEAPOLIS** /
April Greiman **LOS ANGELES** / Malcolm Garrett
[Assorted images] **LONDON** / Rad v. Dommelen
[Proform] **ROTTERDAM** / Matthew Carter
BOSTON

Rudy VanderLans, cover for *Emigre 11* magazine, 1989. Three levels of visual information are layered in dimensional space.

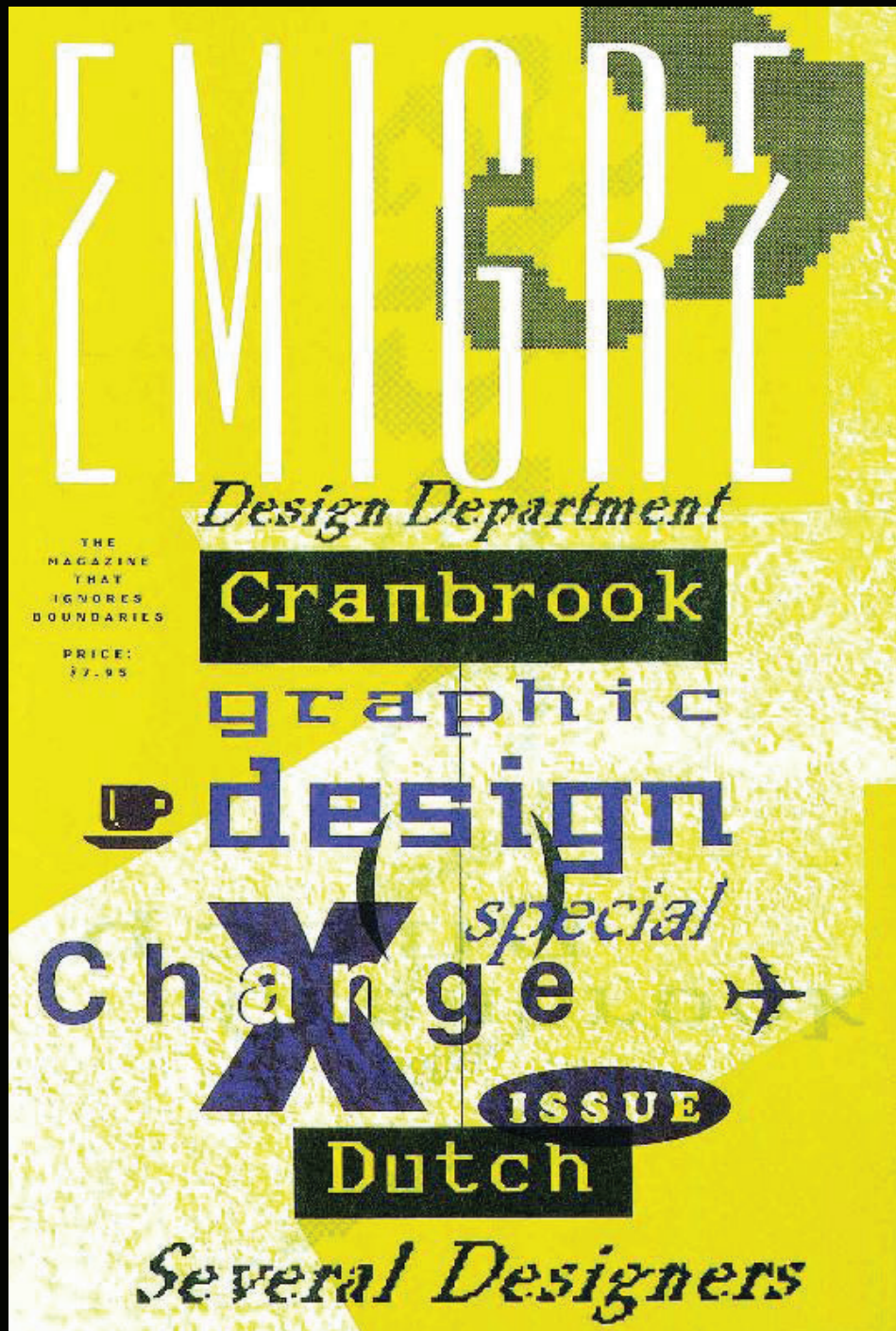

Glenn A. Suokko (designer) and Emigre Graphics, cover for Emigre 10 magazine, 1989. Traditional typographic syntax yielded to an experiment in unconventional information sequencing for a special issue about a graphic design exchange between the Cranbrook and Dutch designers.

